



Work Zone Safety Guidelines

for Municipalities, Utilities and Contractors

March 2013

Table of Contents

| | |
|--|---------|
| Introduction | 2 |
| Traffic Control Devices (Signs, Channelizing Devices, Lighting Devices, Pavement Markings) | 2 - 7 |
| Five Parts of a Traffic Control Zone | 8 |
| Buffer Space Guidance | 9 |
| Taper Length Criteria for Work Zones | 9 - 10 |
| Duration of Work | 11 |
| Use of Flaggers | 11 - 12 |
| | |
| Typical Applications | |
| Definitions | 13 |
| Meaning of Symbols | 14 |
| Daytime Typical Applications from MUTCD (TA-1 to TA-46) (For further information please refer to the index) | 15 - 72 |
| Center Turn Lane Closed on Three-lane Two-way Road (CO-1) | 73 |
| Lane Shift on a Three-lane Two-way Road (CO-2) | 74 |
| Nighttime Typical Applications (NWT A 1 to NWT A 7) (For further information please refer to the index) | 75 - 96 |
| Liability/Supervisor's Checklist | 97 |
| Index | 98-99 |
| Notes | |

Introduction

The purpose of this handbook is to present basic guidelines for work zone traffic control. It supplements the requirements of Part 6 of the Manual on Uniform Traffic Control Devices (MUTCD), and, the Colorado Department of Transportation (CDOT) Standard Plans (M&S Standards). The requirements in this handbook apply to construction, utility, and maintenance work zones.

The sequencing of the typical applications (TA-1 thru TA-46) is the same as that of the MUTCD with the addition of two applications (CO-1 and CO-2) for work where a center turn lane is available to shift traffic. Night work applications (NWT-1 thru NWT-7) have been added to this edition as well. These are the same sequence as found in "NCHRP Report 476 - Guidelines for Design and Operation of Nighttime Traffic Control for Highway Maintenance and Construction". The user of this reference is responsible for understanding and complying with Federal and Local regulations.

Traffic Control Devices

The following four types of traffic control devices are used in work zone traffic control:

- Signs
- Channelizing Devices
- Lighting Devices
- Pavement Markings

Signs

Temporary Traffic Control (TTC) zone signs convey both general and specific messages by means of words, symbols, and/or arrows and have the same three categories as all road user signs: regulatory, warning, and guide. Regulatory signs impose legal restrictions and may not be used without permission from the authority with jurisdiction over the roadway. Guide signs commonly show destinations, directions, and distances. Warning signs give notice of conditions that are potentially hazardous to traffic. Warning signs in TTC zones shall have a black legend and border on an orange background.

Suggested Spacing of Advance Warning Signs

| Road Type | Distance Between Signs* | | |
|----------------------------|-------------------------|-------|-------|
| | A | B | C |
| Urban (35 mph and less) | 100 | 100 | 100 |
| Urban (40 mph and greater) | 350 | 350 | 350 |
| Rural | 500 | 500 | 500 |
| Expressway / Freeway | 1,000 | 1,500 | 2,640 |

*Distances are in feet. The column headings A, B and C are the dimensions as shown in the typical layout diagrams on pages 16 through 96.

Dimensions

Signs used for construction, utility, and maintenance work zone traffic control are normally diamond shaped and shall have a standard size of 48 inches by 48 inches.

Where speeds and volumes are low a minimum size of 36 inches by 36 inches may be used.

Location

Signs are usually located on the right hand side of a street or highway (two-way traffic), but may be located on both sides for some typical applications (four-lane roads with median).

Mounting

Standards for height and lateral clearance of roadside signs are included in Part 6 of the MUTCD. Signs mounted on barricades or temporary supports may be mounted at lower heights but the bottom of the sign shall not be less than one foot above the pavement elevation. Higher mounting heights are desirable.

Illumination and Retro-reflectorization

All signs used during the hours of darkness shall be made of retro-reflective material or illuminated. (Street or highway lighting is not regarded as meeting the requirements for sign illumination.)

Removal

When work is suspended for short periods, all signs that are no longer appropriate shall be removed beyond the clear zone so they are not visible to drivers. The only exceptions are signs that are mounted in the median on saddle type brackets. If the bracket allows the sign to be turned parallel to traffic, it may be turned when not applicable.

Also see page 5 for height and lateral locations of signs.

Channelizing Devices

Channelizing devices are used to warn and alert drivers of hazards in the work zone, to protect workers, and to guide and redirect drivers past the hazards. Channelizing devices include traffic cones, drums, tubular markers, vertical panels, barricades, and barriers.

Traffic Cones

Traffic cones used on Freeways or at night are required to be at least 36 inches tall, and must have two retroreflectorized bands (see illustrations on page 4). The minimum height of cones used on Colorado highways is 28 inches. Traffic cones shall not be used outside of working hours unattended.

Channelizing Devices

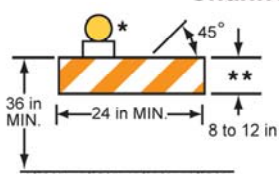

TYPE I BARRICADE

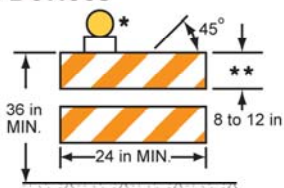

TYPE II BARRICADE

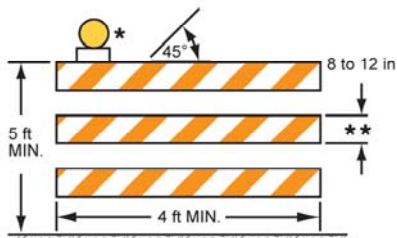

TYPE III BARRICADE



DIRECTION INDICATOR
BARRICADE

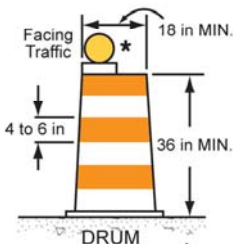

DRUM

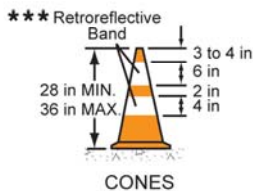

CONES

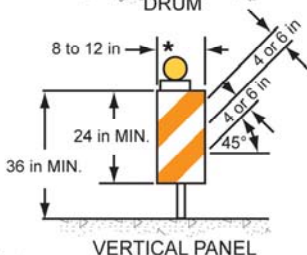

VERTICAL PANEL

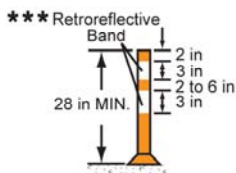

TUBULAR
MARKERS

Notes

1. Stripes on barricade rails slope downward at an angle of 45 degrees toward the direction traffic is to pass. The sides of barricades facing traffic shall have retroreflective rail faces.
2. Barricade rail stripe widths shall be 6 inches except where rail lengths are less than 36 inches, then 4 inch wide stripes may be used.

* Warning lights (optional)

** Normal lumber dimensions are satisfactory for barricade rail width dimensions.

*** Required at night and for 45 mph or higher, optional for day with 40 mph or less.

Height and Lateral Location of Signs - Typical Installation

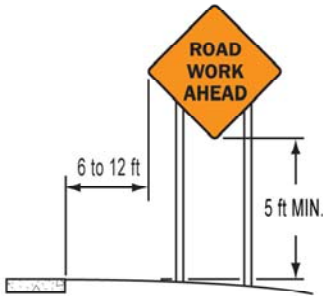

RURAL AREA

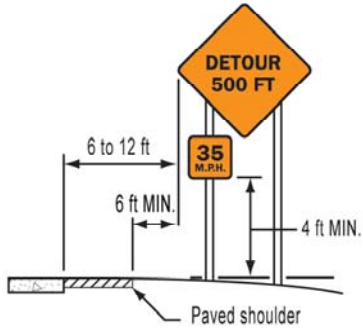

RURAL AREA WITH
ADVISORY SPEED PLAQUE



BUSINESS, COMMERCIAL,
OR RESIDENTIAL AREA

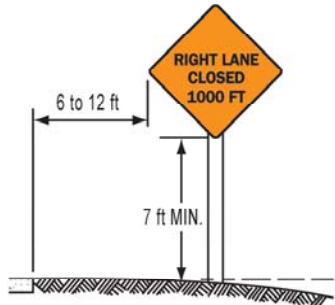

BUSINESS, COMMERCIAL,
OR RESIDENTIAL AREA
(WITHOUT CURB)

Flashing Arrow Panels

An arrow display in the arrow or chevron mode may be used to supplement signs and other devices for lane closures on multilane roadways. An arrow display shall not be used on a two-lane, two-way roadway for temporary one lane operation or on a multilane roadway to shift all lanes of traffic at one location. An arrow display in the caution mode shall be used only for shoulder work, blocking the shoulder, or roadside work near the shoulder. This device provides additional warning and directional information to assist in merging and controlling road uses through or around a temporary traffic control zone.

Advance Warning Arrow Panel Display Specifications

| Operating Mode | Display (Type C arrow panel illustrated) (Right arrow shown, left is similar) |
|----------------|--|
|----------------|--|

1. At least one of the three following modes shall be provided:

Flashing Arrow



Sequential Arrow



Sequential Chevron



2. The following mode shall be provided:
Flashing Double Arrow



3. At least one of the following modes shall be provided:
Flashing Caution or
Alternating Diamond Caution



or



or



| Arrow Panel Type | Use | Minimum Size | Minimum Legibility Distance | Minimum Number of Lamps |
|------------------|--|--------------|-----------------------------|-------------------------|
| A | Urban | 48" x 24" | 1/2 mile | 12 |
| B | Standard | 60" x 30" | 3/4 mile | 13 |
| C | Freeway/ Expressway | 96" x 48" | 1 mile | 15 |
| D | Vehicles Authorized by State or Local Agency | None * | 1/2 mile | 12 |

* Length of arrow equals 48 inches, width of arrow equals 24 inches.

Lighting Devices

Lighting devices for short-term construction, utility, or maintenance operations are designed to supplement the signs and channelizing devices used in the work zone. They are useful in low light conditions where it is difficult for drivers to see signs, channelizing devices, or individual hazards. They include warning lights, flashing vehicle lights, and flashing or sequencing arrow panels.

Warning Lights

Warning lights are available in four types.

Type A - Low Intensity Flashing Lights - used to warn of an isolated hazard at night. Used on low speed urban streets.

Type B -High Intensity Flashing Lights - normally mounted on advanced warning signs to draw the driver's attention to a hazard both day and night. Used on high-speed roadways.

Type C - Low Intensity Steady-Burn Lights and **Type D** - 360-degree Steady-Burn Lights may be used in a series to delineate the edge of the traveled way and channelize traffic at night. Used on high speed, high volume traffic projects.

Type A Low-Intensity Flashing warning lights, Type C Steady-Burn warning lights, and Type D 360-degree Steady-Burn warning lights shall be maintained so as to be capable of being visible on a clear night from a distance of 3,000 feet. Type B High-Intensity Flashing warning lights shall be maintained so as to be capable of being visible on a sunny day when viewed without the sun directly on or behind the device from a distance of 1,000 feet.

Flashing Arrow Panels

See explanation on page 6.

Portable Changeable Message Signs (PCMS)

PCMS may be used to supplement other signs, but not to substitute for any required signs. They can display a variety of messages, but are typically used to display changing condition information. PCMS should consist of no more than two phases, and a phase should consist of no more than three lines of text. The display time for each phase should be at least two seconds, and the sum of the display times for both phases should be a maximum of eight seconds. When a message is longer than two phases, an additional PCMS should be used.

Pavement Markings

For long-term stationary projects, follow the guidelines of Part 6 of the MUTCD in placing and removing pavement markings. The colors of temporary pavement markings and delineators follow the same standard as for permanent markings. White is specified along both sides of two-way roadways and the right side of one-way roadways. Yellow is used on the left side of one-way roadways. Centerlines and lane lines are yellow when separating opposing directions of traffic and white when separating lanes of the same direction. Where existing pavement markings conflict with the temporary travel path, additional signing and channelizing devices are appropriate.

Five Parts of a Traffic Control Zone

The traffic control zone is the distance between the first advance warning sign and the point beyond the work area where traffic is no longer affected. Below is a diagram showing the five parts of a traffic control zone.

Component Parts of a Temporary Traffic Control Zone

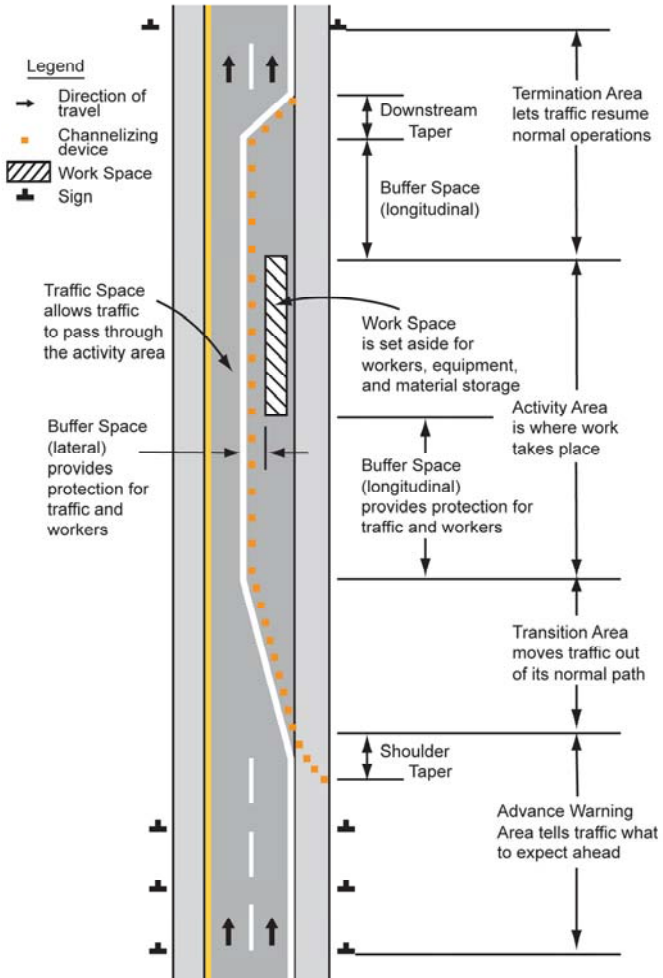

Buffer Space Guidance

The buffer area is a recommended part of the work zone. It serves to separate traffic flow from the work area or a potentially hazardous area and provides recovery space for an errant vehicle. The buffer area should not include any work activity or storage of equipment, vehicles or material. A lateral buffer space may also be used to separate passing traffic from the work area. Its use and width is based on the conditions at the work site.

The use of buffer zones is optional, to be determined on a site-specific basis.

Taper Length Criteria for Work Zones

There are five types of tapers used in work zone traffic control. The length of each type of taper is based on formulas using the speed of the traffic and the width of the offset (or lane width). The following are the five types of tapers. See the table for taper lengths and channelizing device spacing on page 10 for specific taper lengths.

When tapers are to be used on grades or near interchange ramps, crossroads, curves or other influencing factors, it may be desirable to adjust the length of tapers. The test concerning adequate lengths of tapers involves observation of driver performance after traffic control plans are put into effect.

| Type of Taper | Taper Length |
|--|--------------------------------------|
| Merging Taper – The number of lanes is reduced on a multi-lane road | L |
| Shifting Taper – A lateral shift, but no reduction in the number of travel lanes | 1/2 L |
| Shoulder Taper – The shoulder is closed | 1/3 L |
| One-Lane, Two-Way Traffic Taper – Opposing directions of traffic share one open lane | 50 feet minimum, 100 feet maximum |
| Downstream Tapers (Optional) – The work area ends and all lanes are again open to traffic | 50 feet minimum, 100 feet maximum |

Formulas for L

| Speed Limit | Formula |
|-------------------|-----------------|
| 40 MPH or Less | $L = WS^2 / 60$ |
| 45 MPH or Greater | $L = WS$ |

where:

L = taper length in feet

W = width of offset in feet

S = posted speed, or off-peak 85th percentile speed prior to work starting, or the anticipated operating speed in MPH

Taper Length, Number of Devices, and Device Spacing Table

| Speed | Min. Merging Taper Length (L) in Feet | | | Minimum Number of Devices | | | Maximum Device Spacing in Feet | | Speed |
|------------|---------------------------------------|-----|-----|---------------------------|----|----|--------------------------------|---------------|------------|
| | 10 | 11 | 12 | Lane Width (W) in Feet | | | Along Taper | Along Tangent | |
| 25 or less | 105 | 115 | 125 | 6 | 6 | 6 | 25 | 50 | 25 or less |
| 30 | 150 | 165 | 180 | 6 | 7 | 7 | 30 | 60 | 30 |
| 35 | 205 | 225 | 245 | 7 | 8 | 8 | 35 | 70 | 35 |
| 40 | 270 | 295 | 320 | 8 | 9 | 9 | 40 | 80 | 40 |
| 45 | 450 | 495 | 540 | 11 | 12 | 13 | 45 | 90 | 45 |
| 50 | 500 | 550 | 600 | 11 | 12 | 13 | 50 | 100 | 50 |
| 55 | 550 | 605 | 660 | 11 | 12 | 13 | 55 | 110 | 55 |
| 60 | 600 | 660 | 720 | 11 | 12 | 13 | 60 | 120 | 60 |
| 65 | 650 | 725 | 780 | 11 | 12 | 13 | 65 | 130 | 65 |
| 70 | 700 | 770 | 840 | 11 | 12 | 13 | 70 | 140 | 70 |
| 75 | 750 | 825 | 900 | 11 | 12 | 13 | 75 | 150 | 75 |
| 80 | 800 | 880 | 960 | 11 | 12 | 13 | 80 | 160 | 80 |

Duration of Work

Work duration is a major factor in determining the number and types of devices used in temporary traffic control zones. As a general rule, the longer the operation will last, the more traffic control devices are needed.

- A. Long-Term Stationary - Work that occupies a location more than 3 days.
- B. Intermediate-Term Stationary - Work that occupies a location from overnight to 3 days, or nighttime work lasting more than 1 hour.
- C. Short-Term Stationary- Daytime work that occupies a location for 1 to 12 hours.
- D. Short Duration - Work that occupies a location up to 1 hour.
- E. Mobile - Work that moves intermittently (stops up to 15 minutes) or continuously.

Use of Flaggers

A flagger is a person who provides temporary traffic control. Flaggers shall be properly trained and shall be equipped with:

- approved sign paddles,
- hard hats
- approved safety vests, and
- reflective night equipment.

Flagger stations shall be located far enough in advance of the work area so that approaching road users will have sufficient distance to stop before entering the work area (see table below for guidelines). Proper flagging stations shall:

- provide good approach sight distance,
- be highly visible to traffic and
- be illuminated at night.

Proper advance warning signs shall be provided. Signs shall be removed when not flagging.

The flagger should stand on the shoulder or in the closed lane adjacent to the lane being controlled – never in the moving traffic lane. The flagger should be stationed sufficiently in advance of workers to warn them of approaching danger by out-of-control vehicles.

Distance of Flagger Station in Advance of Work Space (May also be used to compute length of buffer zone.)

| | | | | | | | | | | | | |
|--------------------------|------------|------------|------------|------------|------------|------------|------------|------------|------------|------------|------------|------------|
| Speed* (mph) | 20 | 25 | 30 | 35 | 40 | 45 | 50 | 55 | 60 | 65 | 70 | 75 |
| Distance (ft) | 115 | 155 | 200 | 250 | 305 | 360 | 425 | 495 | 570 | 645 | 730 | 820 |

*Posted speed, off-peak 85th-percentile speed prior to work starting, or the anticipated operating speed

Use of Hand-Signaling Devices by Flaggers

PREFERRED METHOD
STOP/SLOW Paddle

EMERGENCY SITUATIONS ONLY
Red Flag

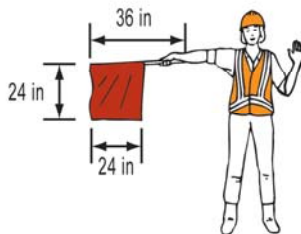

TO STOP TRAFFIC



TO LET
TRAFFIC PROCEED



TO ALERT AND
SLOW TRAFFIC

Typical Application Diagrams

The Typical Application diagrams on the following pages are selected Typical Applications from the MUTCD (TA-1 through TA-46) with the addition of two typical applications for three-lane, two-way roads (CO-1 and CO-2). The applications in this book were selected with a focus on short term and most commonly used setups. For details on additional applications see Part 6H of the MUTCD and S-630-1 of the CDOT M&S Standards. The Night Work Typical Applications (NWT A-1 through NWT A-7) are taken from "NCHRP Report 476 – Guidelines for Design and Operation of Nighttime Traffic Control for Highway Maintenance and Construction".

Definitions

The following are several important definitions for terms used in these guidelines. These definitions were developed to aid the supervisor at the job site in determining the appropriate traffic control for the existing street or highway conditions. If the traffic conditions change during the course of the work then the traffic control must change also.

Low Volume - As a general rule, a low volume road can be considered one on which the average daily traffic volume (ADT) does not exceed 400 vehicles per day.

Rule of Thumb: Count the number of vehicles that pass a single reference point over a five (5) minute period. If not more than 3 vehicles pass the reference point in that period, then the road can be considered low volume for the purpose of installing work zone traffic control.

In addition, special attention should be given to local, nearby facilities, such as schools, manufacturing plants, etc., that cause special traffic generation. Consideration should also be given as to whether the work zone location is subject to peak hour traffic increases. Peak hours are usually 7-9 a.m. and 4-6 p.m., and will vary in different areas. In some urban areas work is restricted during peak hour times. Always check with the appropriate highway agency.



Urban Street - This is generally a two-lane, low speed, city street located inside a municipality's corporate limit. A subdivision street that is not within a municipality's corporate limits but has the same urban characteristics may also be classified as an urban street.

Minor Urban Street - A low volume, urban street.

Meaning of Symbols on Typical Application Diagrams

| | |
|---|--|
|  | Arrow panel |
|  | Arrow panel support or trailer |
|  | Channelizing device |
|  | Direction of traffic |
|  | Flagger |
|  | High-level warning device (Flag tree) |
|  | Longitudinal channelizing device |
|  | Luminaire |
|  | Sign (Shown facing left) |
|  | Temporary barrier |
|  | Temporary barrier with warning lights |
|  | Traffic or pedestrian signal |
|  | Truck mounted attenuator |
|  | Type 3 barricade |
|  | Crash cushion |
|  | Changeable message sign or support trailer |
|  | Warning lights |
|  | Workspace |
|  | Work vehicle |
|  | Shadow vehicle |

Additional Devices for Night Work

| | |
|---|---|
|  | Portable light tower – rays indicate direction of aim |
|  | Arrestor net |
|  | Intrusion alarm |
|  | Police cruiser |
|  | Watch guard vehicle |

Notes for Typical Application 1
Work Beyond the Shoulder

Guidance:

1. If the workspace is in the median of a divided highway, an advance warning sign should also be placed on the left side of the directional roadway.

Option:

2. The ROAD WORK AHEAD sign may be replaced with other appropriate signs such as the SHOULDER WORK sign. The SHOULDER WORK sign may be used for work adjacent to the shoulder.

3. The ROAD WORK AHEAD sign may be omitted where the work space is behind a barrier, more than 24 inches behind the curb, or 15 feet or more from the edge of any roadway.

4. For short-term, short-duration or mobile operation*, all signs and channelizing devices may be eliminated if a vehicle with activated high-intensity rotating, flashing, oscillating, or strobe lights is used.

5. Vehicle hazard warning signals may be used to supplement high-intensity rotating, flashing, oscillating, or strobe lights.

Standard:

6. Vehicle hazard warning signals shall not be used instead of the vehicle's high-intensity rotating, flashing, oscillating, or strobe lights.

* See page 11 for duration definitions

Work Beyond the Shoulder (TA-1)

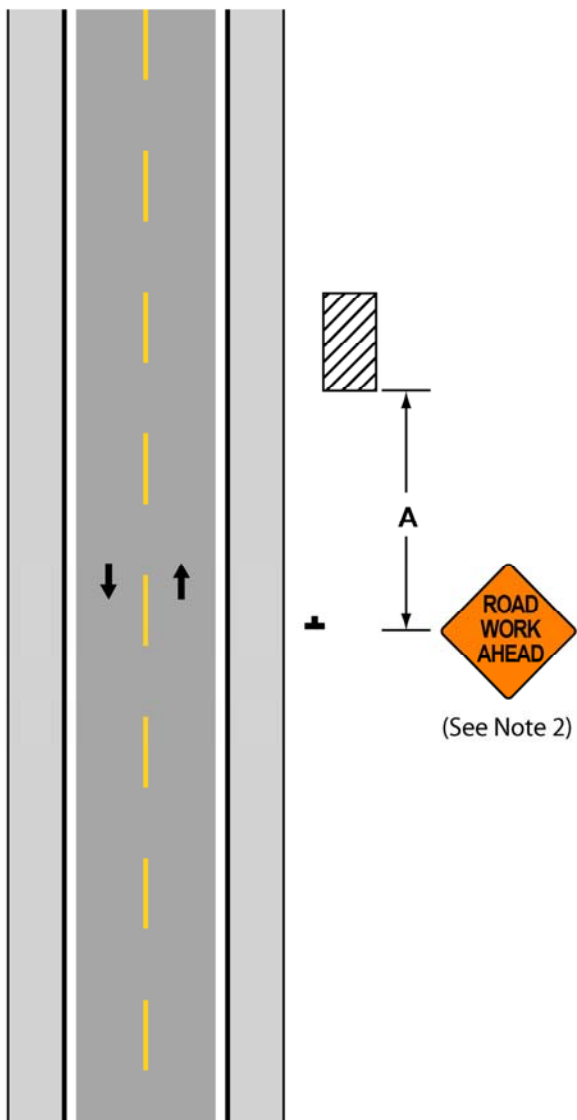

**Notes for Typical Application 3
Work on Shoulders**

Guidance:

1. A *SHOULDER WORK* sign should be placed on the left side of the roadway for a divided or one-way street only if the left shoulder is affected.

Option:

2. The Workers symbol signs may be used instead of *SHOULDER WORK* signs.

3. The *SHOULDER WORK AHEAD* sign on an intersecting roadway may be omitted where drivers emerging from that roadway will encounter another advance warning sign prior to this activity area.

4. For short-duration operations of 60 minutes or less, all signs and channelizing devices may be eliminated if a vehicle with activated high-intensity rotating, flashing, oscillating, or strobe lights is used.

5. Vehicle hazard warning signals may be used to supplement high-intensity rotating, flashing, oscillating, or strobe lights.

Standard:

6. Vehicle hazard warning signals shall not be used instead of the vehicle's high-intensity rotating, flashing, oscillating, or strobe lights.

7. When paved shoulders having a width of 8 feet or more are closed, at least one advance warning sign shall be used. In addition, channelizing devices shall be used to close the shoulder in advance to delineate the beginning of the work space and direct vehicular traffic to remain within the traveled way.

Work on Shoulders (TA-3)

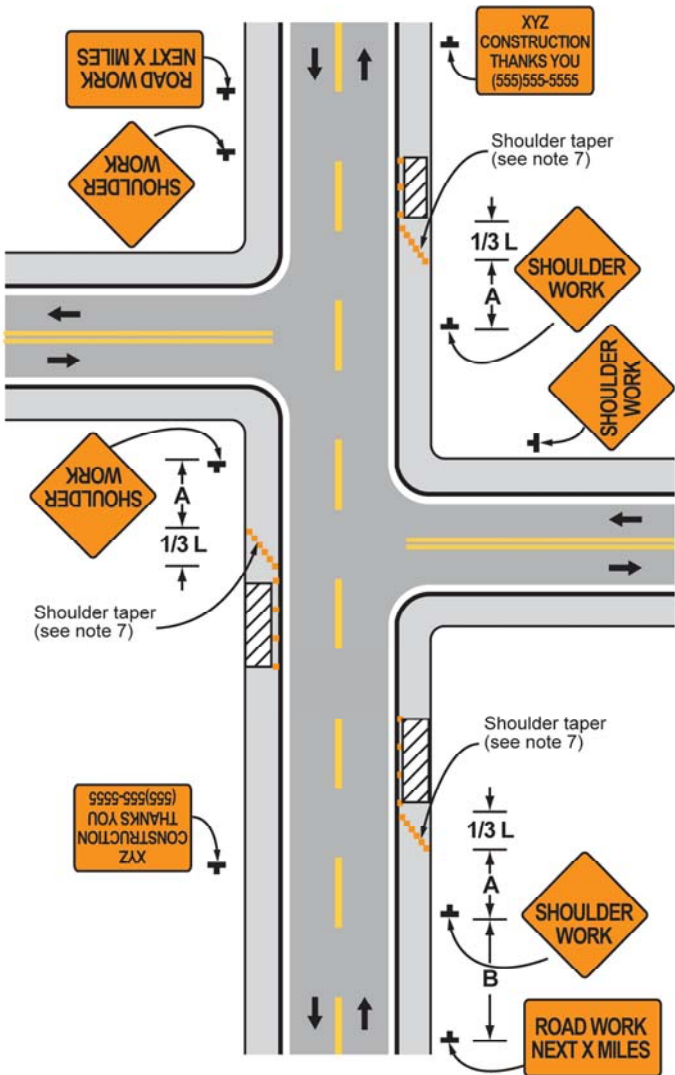

Notes for Typical Application 4
Short-Duration or Mobile Operation on Shoulder

Guidance:

1. *In those situations where multiple work locations within a limited distance make it practical to place stationary signs, the distance between the advance warning sign and the work should not exceed 5 miles.*
2. *In those situations where the distance between the advance signs and the work is 2 miles to 5 miles, a Supplemental Distance plaque should be used with the ROAD WORK AHEAD sign.*

Option:

3. The ROAD WORK NEXT XX MILES sign may be used instead of the ROAD WORK AHEAD sign if the work locations occur over a distance of more than 2 miles.
4. Stationary warning signs may be omitted for short duration or mobile operations if the work vehicle displays high-intensity rotating, flashing, oscillating, or strobe lights.
5. Vehicle hazard warning signals may be used to supplement high-intensity rotating, flashing, oscillating, or strobe lights.

Standard:

6. **Vehicle hazard warning signals shall not be used instead of the vehicle's high-intensity rotating, flashing, oscillating, or strobe lights.**
7. **If an arrow panel is used for an operation on the shoulder, the caution mode shall be used.**
8. **Vehicle-mounted signs shall be mounted in a manner such that they are not obscured by equipment or supplies. Sign legends on vehicle-mounted signs shall be covered or turned from view when work is not in progress.**

Short-Duration or Mobile Operation on Shoulder (TA-4)

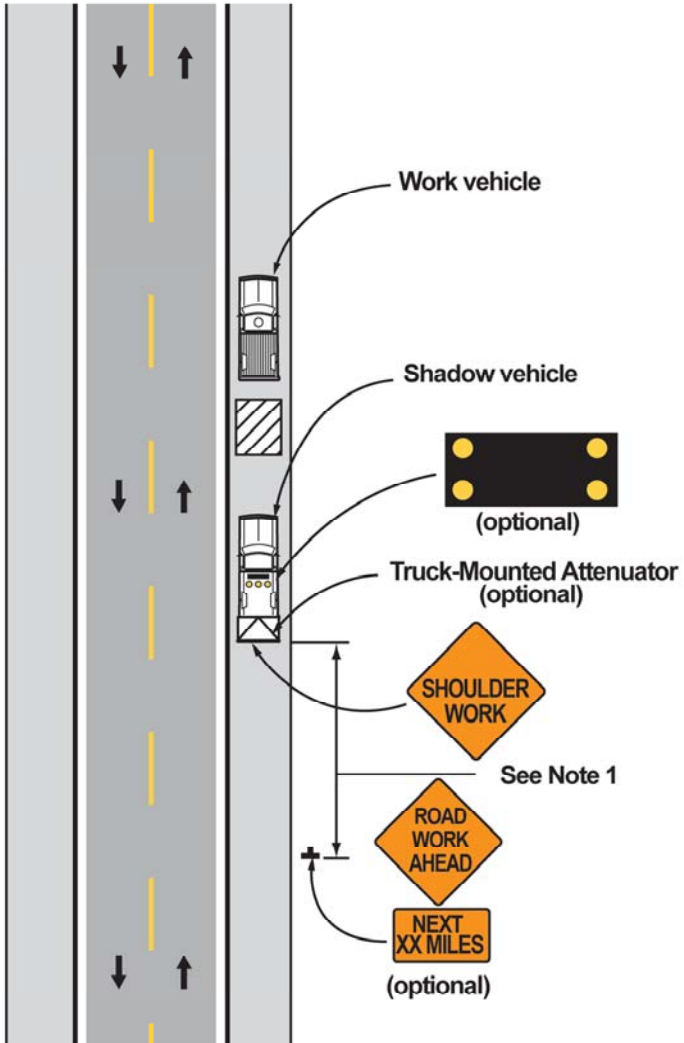

Notes for Typical Application 5 Shoulder Closure on Freeway

Guidance:

- 1. SHOULDER CLOSED signs should be used on limited-access highways where there is no opportunity for disabled vehicles to pull off the roadway.*
- 2. If drivers cannot see a pull-off area beyond the closed shoulder, information regarding the length of the shoulder closure should be provided in feet or miles, as appropriate.*
- 3. The use of a temporary traffic barrier should be based on engineering judgment.*

Standard:

- 4. Temporary traffic barriers, if used, shall comply with the provisions of Section 6F.85 of the MUTCD.**

Option:

- 5. The barrier shown in this typical application is an example of one method that may be used to close a shoulder of a long-term project.*
- 6. The warning lights shown on the barrier may be used.*

Shoulder Closure on Freeway (TA-5)

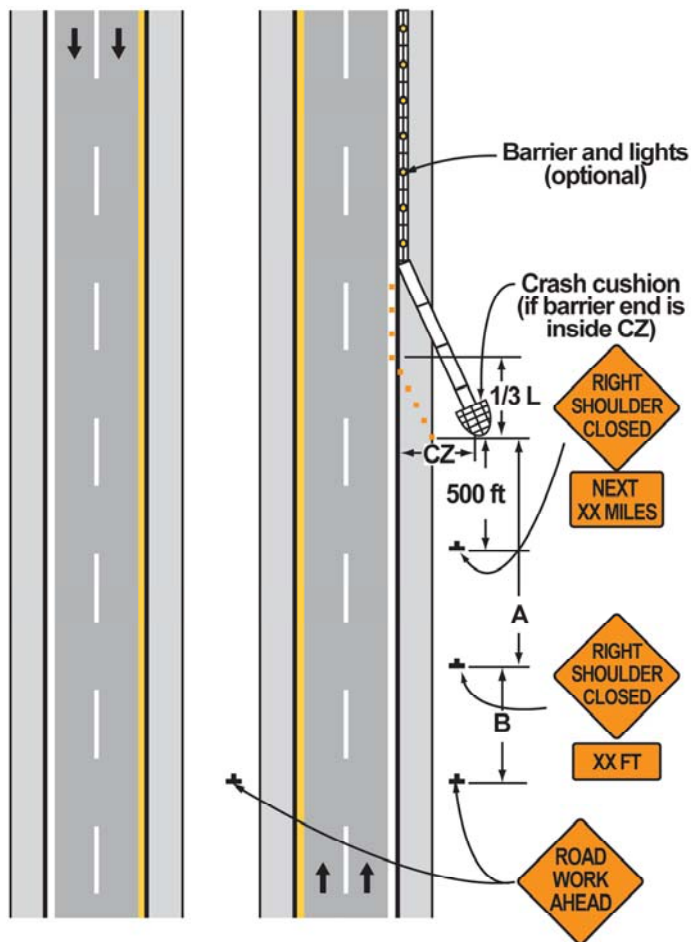

Notes for Typical Application 6
Shoulder Work with Minor Encroachment

Guidance:

1. All lanes should be a minimum of 10 feet in width as measured to the near face of the channelizing devices.
2. The treatment shown should be used on a minor road having low speeds. For higher-speed traffic conditions, a lane closure should be used.

Option:

3. For short-term* use on low-volume, low-speed roadways with vehicular traffic that does not include longer and wider heavy commercial vehicles, a minimum lane width of 9 feet may be used.
4. Where the opposite shoulder is suitable for carrying vehicular traffic and of adequate width, lanes may be shifted by use of closely-spaced channelizing devices, provided that the minimum lane width of 10 feet is maintained.
5. Additional advance warning may be appropriate, such as a ROAD NARROWS sign.
6. Temporary traffic barriers may be used along the work space.
7. The shadow vehicle may be omitted if a taper and channelizing devices are used.
8. A truck-mounted attenuator may be used on the shadow vehicle.
9. For short-duration* work, the taper and channelizing devices may be omitted if a shadow vehicle with activated high-intensity rotating, flashing, oscillating, or strobe lights is used.
10. Vehicle hazard warning signals may be used to supplement high-intensity rotating, flashing, oscillating, or strobe lights.

Standard:

11. **Vehicle-mounted signs shall be mounted in a manner such that they are not obscured by equipment or supplies. Sign legends on vehicle-mounted signs shall be covered or turned from view when work is not in progress.**
12. **Shadow and work vehicles shall display high-intensity rotating, flashing, oscillating, or strobe lights.**
13. **Vehicle hazard warning signals shall not be used instead of the vehicle's high-intensity rotating, flashing, oscillating, or strobe lights.**

* See page 11 for duration definitions

Shoulder Work with Minor Encroachment (TA-6)

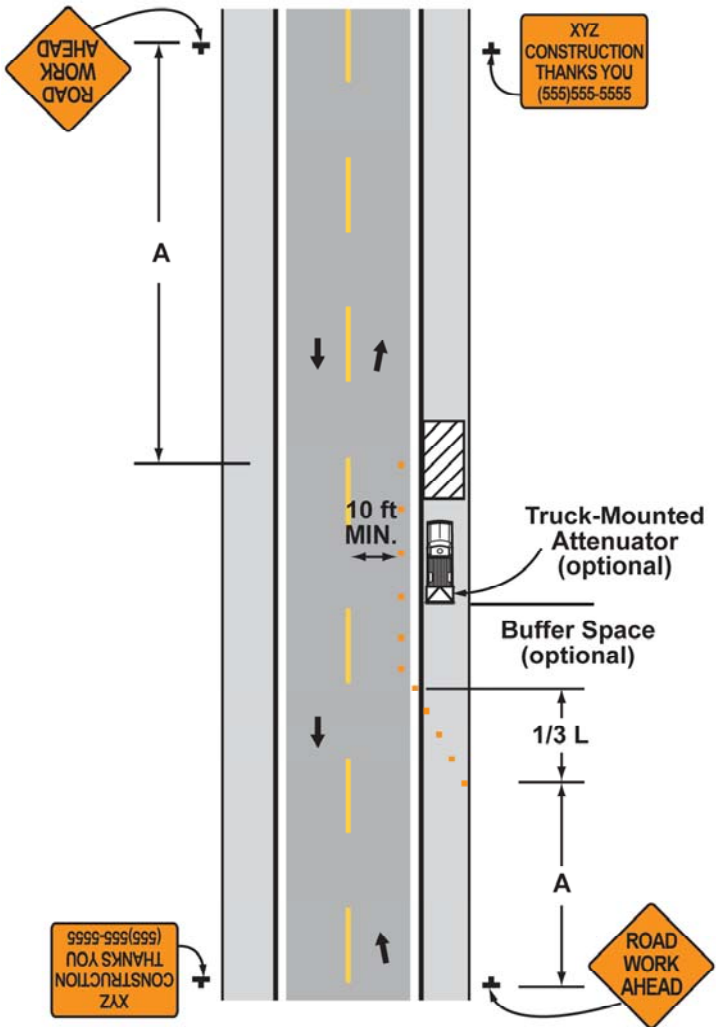

Notes for Typical Application 7 Road Closure with Diversion

Support:

1. Signs and object markers are shown for one direction of travel only.

Standard:

2. **Devices similar to those depicted shall be placed for the opposite direction of travel.**
3. **Pavement markings no longer applicable to the traffic pattern of the roadway shall be removed or obliterated before any new traffic patterns are open to traffic.**
4. **Temporary barriers and end treatments shall be crashworthy.**

Guidance:

5. *If the tangent distance along the temporary diversion is more than 600 feet, a Reverse Curve sign, left first, should be used instead of the Double Reverse Curve sign, and a second Reverse Curve sign, right first, should be placed in advance of the second reverse curve back to the original alignment.*
6. *When the tangent section of the diversion is more than 600 feet, and the diversion has sharp curves with recommended speeds of 30 mph or less, Reverse Turn signs should be used.*
7. *Where the temporary pavement and old pavement are different colors, the temporary pavement should start on the tangent of the existing pavement and end on the tangent of the existing pavement.*

Option:

8. Flashing warning lights and/or flags may be used to call attention to the warning signs.
9. On sharp curves, large arrow signs may be used in addition to other advance warning signs.
10. Delineators or channelizing devices may be used along the diversion.

Road Closure with Diversion (TA-7)

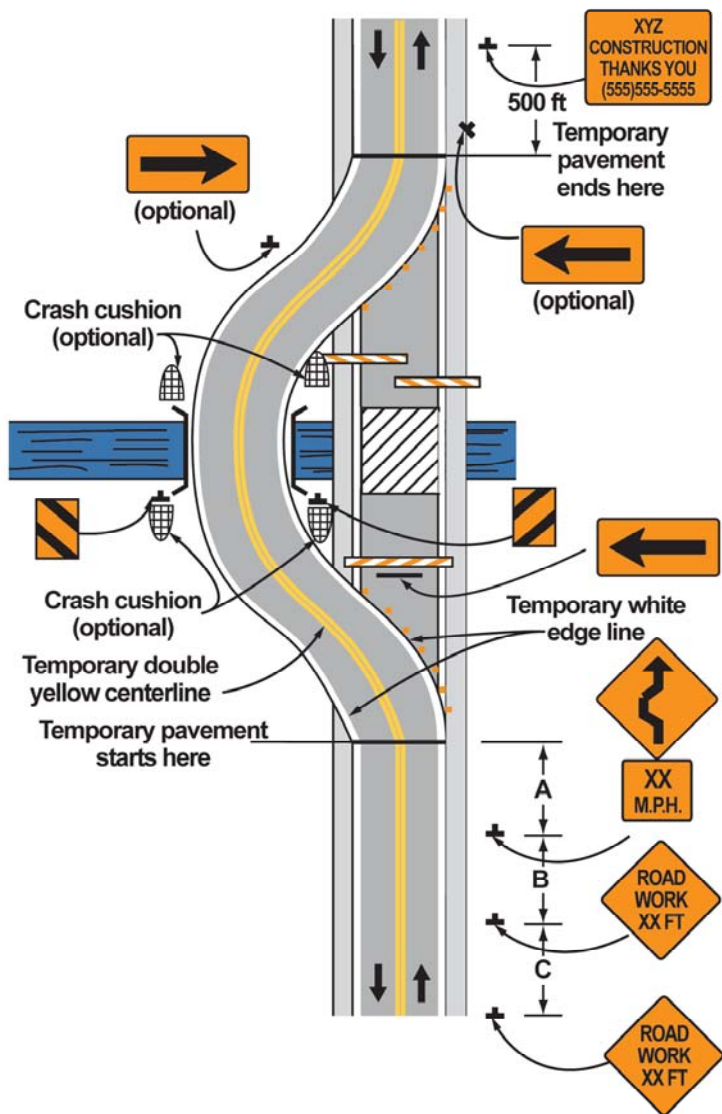

**Notes for Typical Application 8
Road Closure with Off-Site Detour**

Guidance:

1. Regulatory traffic control devices should be modified as needed for the duration of the detour.

Option:

2. If the road is opened for some distance beyond the intersection and/or there are significant origin/destination points beyond the intersection, the ROAD CLOSED and DETOUR signs on Type 3 Barricades may be located at the edge of the traveled way.

3. A Route Sign Directional assembly may be placed on the far left corner of the intersection to augment or replace the one shown on the near right corner.

4. Flashing warning lights and/or flags may be used to call attention to the advance warning signs.

5. Cardinal direction plaques may be used with route signs.

Road Closure with Off-Site Detour (TA-8)

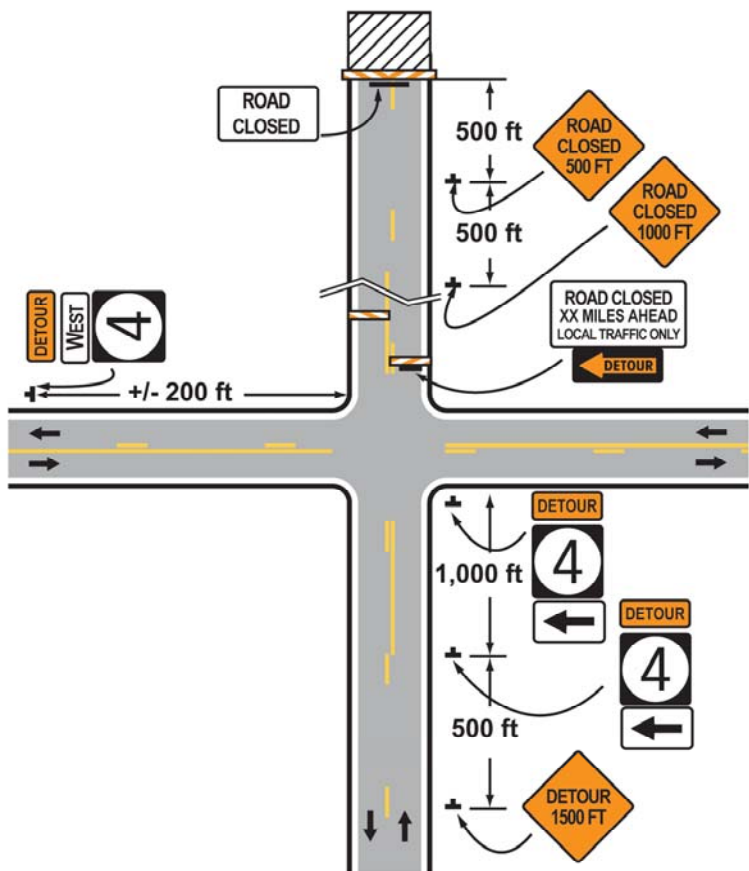

Notes for Typical Application 10

Lane Closure on Two-Lane Road Using Flaggers

Option:

1. For low-volume situations with short work zones on straight roadways where the flagger is visible to road users approaching from both directions, a single flagger, positioned to be visible to road users approaching from both directions, may be used (see Chapter 6E of the MUTCD for more information).

2. The ROAD WORK AHEAD and the END ROAD WORK signs may be omitted for short-duration* operations.

3. Flashing warning lights and/or flags may be used to call attention to the advance warning signs. A BE PREPARED TO STOP sign may be added to the sign series.

Guidance:

4. *The buffer space should be extended so that the two-way traffic taper is placed before a horizontal (or crest vertical) curve to provide adequate sight distance for the flagger and a queue of stopped vehicles.*

Standard:

5. At night, flagger stations shall be illuminated, except in emergencies.

Guidance:

6. *When used, the BE PREPARED TO STOP sign should be located between the Flagger sign and the ONE LANE ROAD sign.*

7. *When a grade crossing exists within or upstream of the transition area and it is anticipated that queues resulting from the lane closure might extend through the grade crossing, the TTC zone should be extended so that the transition area precedes the grade crossing.*

8. *When a grade crossing equipped with active warning devices exists within the activity area, provisions should be made for keeping flaggers informed as to the activation status of these warning devices.*

9. *When a grade crossing exists within the activity area, drivers operating on the left-hand side of the normal center line should be provided with comparable warning devices as for drivers operating on the right-hand side of the normal center line.*

10. *Early coordination with the railroad company or light rail transit agency should occur before work starts.*

Option:

11. A flagger or a uniformed law enforcement officer may be used at the grade crossing to minimize the probability that vehicles are stopped within 15 feet of the grade crossing, measured from both sides of the outside rails.

* See page 11 for duration definitions

Lane Closure on Two Lane Road Using Flaggers (TA-10)

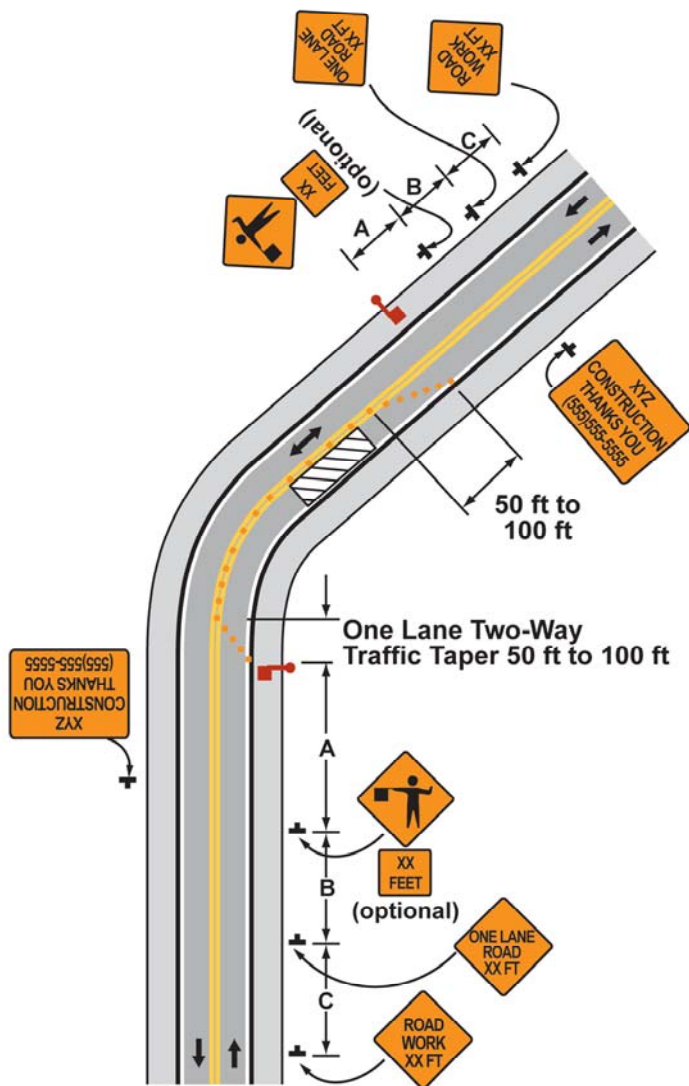

Notes for Typical Application 12

Lane Closure on Two-Lane Road Using Traffic Control Signals

Standard:

1. Temporary traffic control signals shall be installed and operated in accordance with the provisions of Part 4 of the MUTCD. Temporary traffic control signals shall meet the physical display and operational requirements of conventional traffic control signals.
2. Temporary traffic control signal timing shall be established by authorized officials. Durations of red clearance intervals shall be adequate to clear the one-lane section of conflicting vehicles.
3. When the temporary traffic control signal is changed to the flashing mode, either manually or automatically, red signal indications shall be flashed to both approaches.
4. Stop lines shall be installed with temporary traffic control signals for intermediate* and long-term* closures. Existing conflicting pavement markings and raised pavement marker reflectors between the activity area and the stop line shall be removed. After the temporary traffic control signal is removed, the stop lines and other temporary pavement markings shall be removed and the permanent pavement markings restored.
5. Safeguards shall be incorporated to avoid the possibility of conflicting signal indications at each end of the TTC zone.

Guidance:

6. *Where no-passing lines are not already in place, they should be added.*
7. *Adjustments in the location of the advance warning signs should be made as needed to accommodate the horizontal or vertical alignment of the roadway, recognizing that the distances shown for sign spacings are minimums. Adjustments in the height of the signal heads should be made as needed to conform to the vertical alignment.*

Option:

8. Flashing warning lights shown on the ROAD WORK AHEAD and the ONE LANE ROAD AHEAD signs may be used.
9. Removable pavement markings may be used.

Support:

10. Temporary traffic control signals are preferable to flaggers for long-term projects and other activities that would require flagging at night.
11. The maximum length of activity area for one-way operation under temporary traffic control signal control is determined by the capacity required to handle the peak demand.

* See page 11 for duration definitions

Lane Closure on Two-Lane Road Using Traffic Control Signals (TA-12)

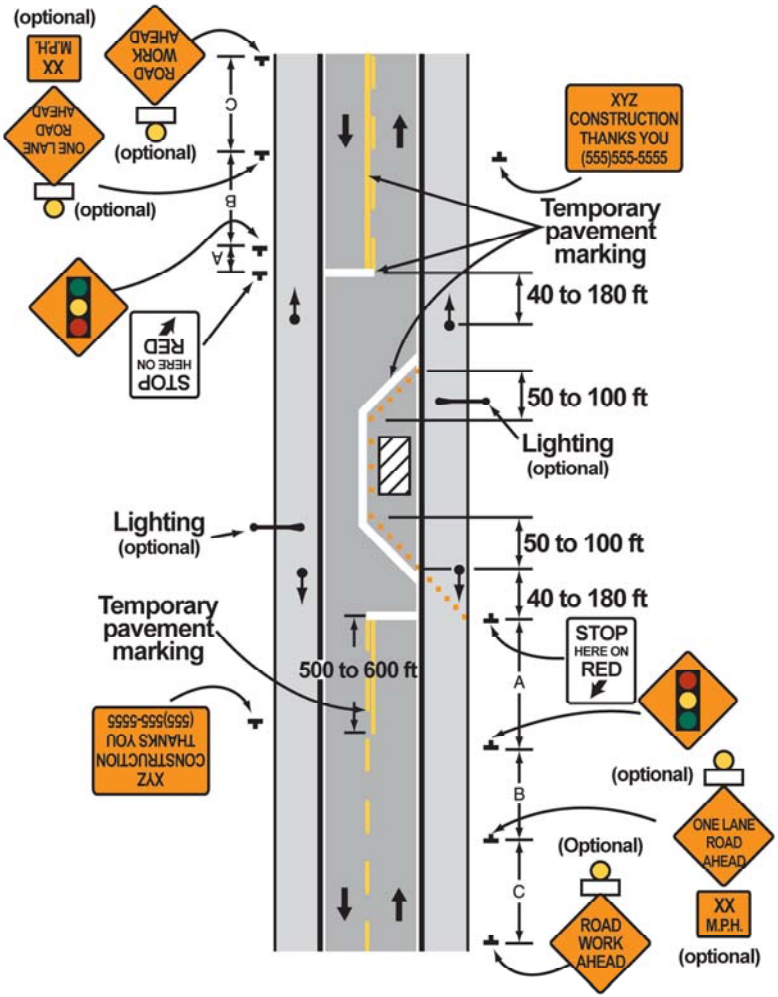

Notes for Typical Application 13
Temporary Road Closure

Support:

1. Conditions represented are a planned closure not exceeding 20 minutes during the daytime.

Standard:

- 2. A flagger or uniformed law enforcement officer shall be used for this application. The flagger, if used for this application, shall follow the procedures provided in Sections 6E.07 and 6E.08 of the MUTCD.**

Guidance:

- 3. The uniformed law enforcement officer, if used for this application, should follow the procedures provided in Sections 6E.07 and 6E.08 of the MUTCD.*

Option:

4. A BE PREPARED TO STOP sign may be added to the sign series.

Guidance:

- 5. When used, the PREPARED TO STOP sign should be located before the Flagger symbol sign.*

Temporary Road Closure (TA-13)

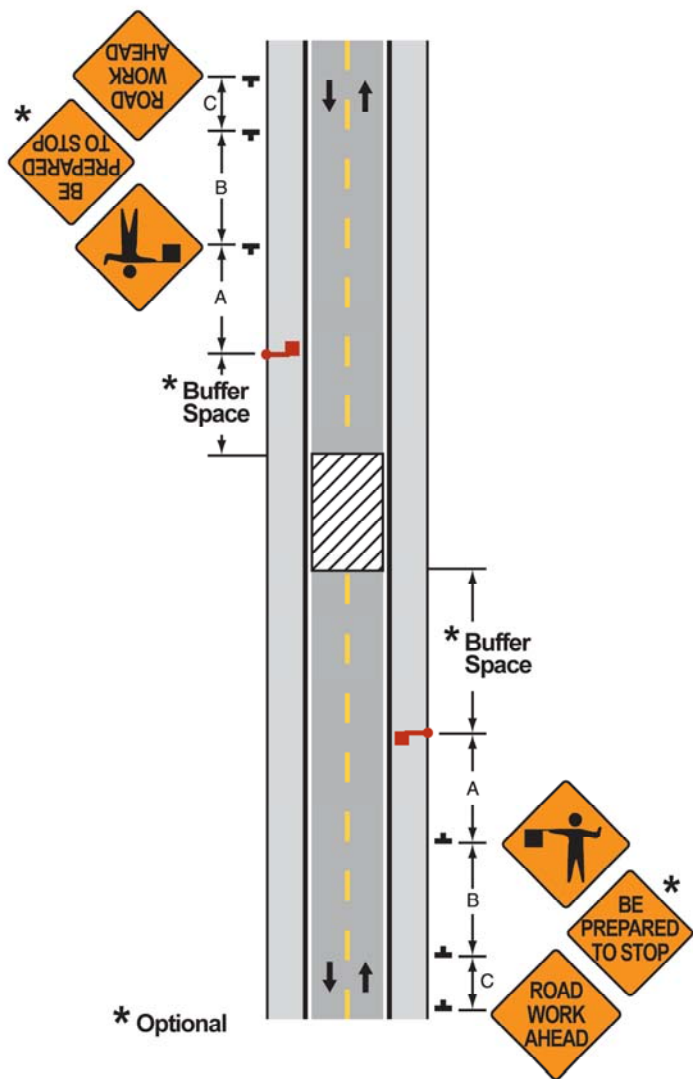

Notes for Typical Application 15
Work in the Center of a Road with Low Traffic Volumes

Guidance:

1. The lanes on either side of the center work space should have a minimum width of 10 feet as measured from the near edge of the channelizing devices to the edge of pavement or the outside edge of paved shoulder.

Option:

2. Flashing warning lights and/or flags may be used to call attention to the advance warning signs.

3. If the closure continues overnight, warning lights may be used on the channelizing devices.

4. A lane width of 9 feet may be used for short-term* stationary work on low-volume, low-speed roadways when motor vehicle traffic does not include longer and wider heavy commercial vehicles.

5. A work vehicle displaying high-intensity rotating, flashing, oscillating, or strobe lights may be used instead of the channelizing devices forming the tapers or the high-level warning devices.

6. Vehicle hazard warning signals may be used to supplement high-intensity rotating, flashing, oscillating, or strobe lights.

Standard:

7. Vehicle hazard warning signals shall not be used instead of the vehicle's high-intensity rotating, flashing, oscillating, or strobe lights.

* See page 11 for duration definitions

Work in the Center of a Road with Low Traffic Volumes (TA-15)

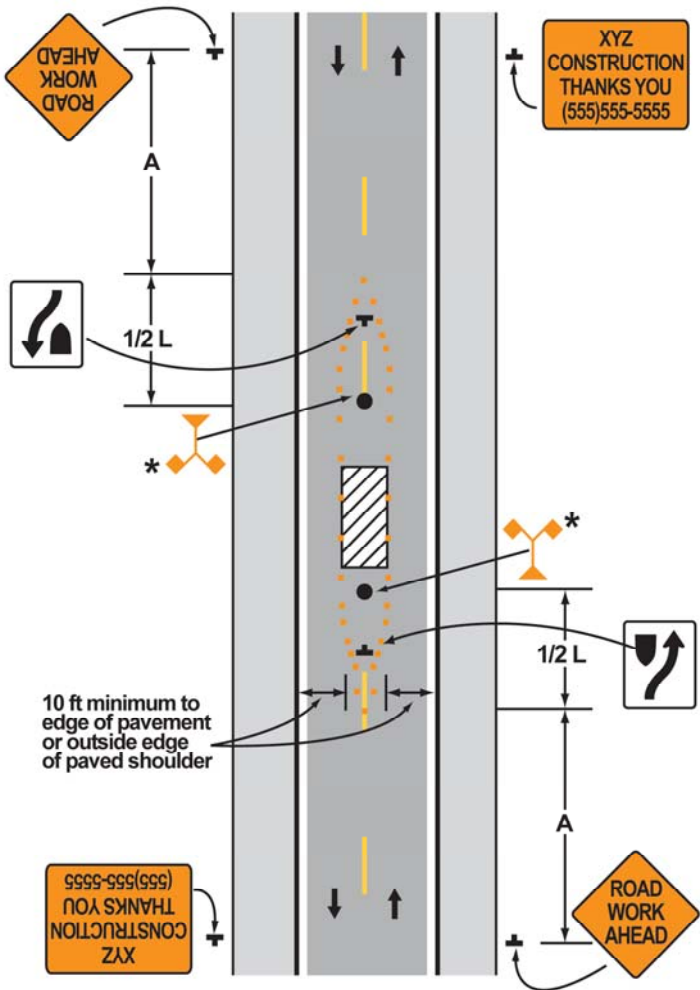

* Optional

Notes for Typical Application 16
Surveying Along Centerline of Road with Low Traffic Volumes

Guidance:

1. The lanes on either side of the center work space should have a minimum width of 10 feet as measured from the near edge of the channelizing devices to the edge of the pavement or the outside edge of the paved shoulder.
2. Cones should be placed 6 to 12 inches on either side of the center line.
3. A flagger should be used to warn workers who cannot watch road users.

Standard:

4. **For surveying on the centerline of a high-volume road, one lane shall be closed using the information illustrated in Typical Application 10.**

Option:

5. A high-level warning device may be used to protect a surveying device, such as a target on a tripod.
6. Cones may be omitted for a cross-section survey.
7. ROAD WORK AHEAD signs may be used in place of the SURVEY CREW AHEAD signs.
8. Flags may be used to call attention to the advance warning signs.
9. If the work is along the shoulder, the flagger may be omitted.
10. For a survey along the edge of the road or along the shoulder, cones may be placed along the edge line.
11. A BE PREPARED TO STOP sign may be added to the sign series.

Guidance:

12. *When used, the BE PREPARED TO STOP sign should be located before the Flagger symbol sign.*

**Surveying Along the Center Line of a Road
with Low Traffic Volumes (TA-16)**

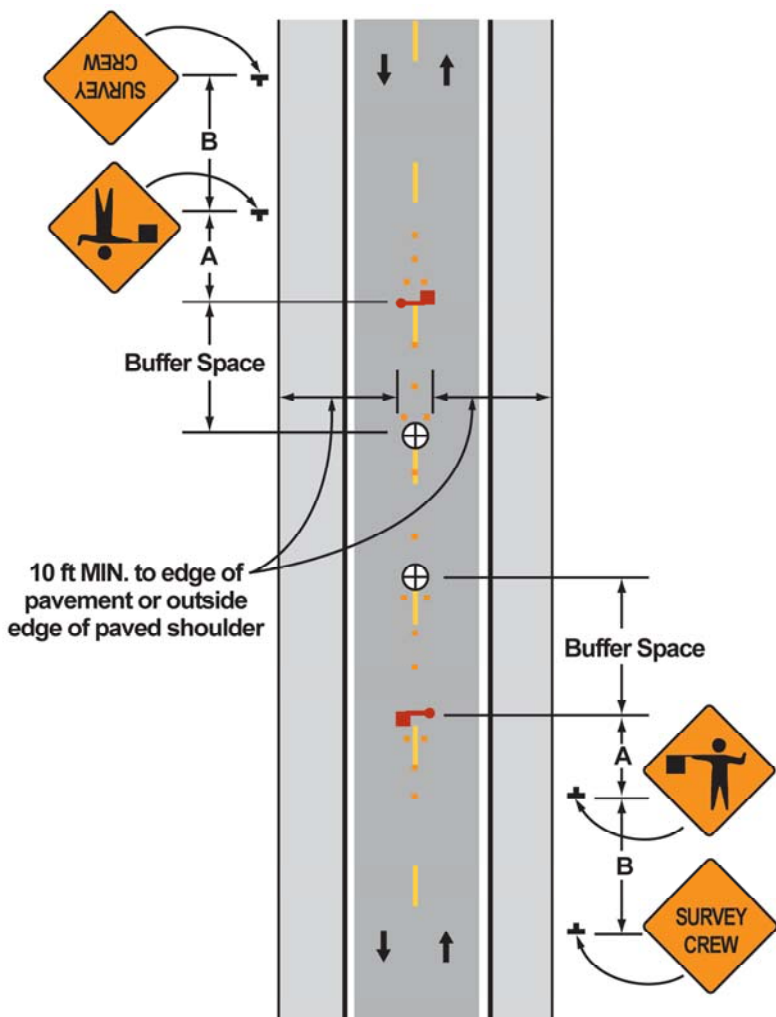

Notes for Typical Application 17
Mobile* Operations on Two-Lane Road

Standard:

1. Vehicle-mounted signs shall be mounted in a manner such that they are not obscured by equipment or supplies. Sign legends on vehicle-mounted signs shall be covered or turned from view when work is not in progress.
2. Shadow and work vehicles shall display high-intensity rotating, flashing, oscillating, or strobe lights.
3. If an arrow panel is used, it shall be used in the caution mode.

Guidance:

4. Where practical and when needed, the work and shadow vehicles should pull over periodically to allow vehicular traffic to pass.
5. Whenever adequate stopping sight distance exists to the rear, the shadow vehicle should maintain the minimum distance from the work vehicle and proceed at the same speed. The shadow vehicle should slow down in advance of vertical or horizontal curves that restrict sight distance.
6. The shadow vehicles should also be equipped with two high-intensity flashing lights mounted on the rear, adjacent to the sign.

Option:

7. The distance between the work and shadow vehicles may vary according to terrain, paint drying time, and other factors.
8. Additional shadow vehicles to warn and reduce the speed of oncoming or opposing motor vehicle traffic may be used. Law enforcement vehicles may be used for this purpose.
9. A truck-mounted attenuator may be used on the shadow vehicle or on the work vehicle.
10. If the work and shadow vehicles cannot pull over to allow vehicular traffic to pass frequently, a DO NOT PASS sign may be placed on the rear of the vehicle blocking the lane.

Support:

11. Shadow vehicles are used to warn motor vehicle traffic of the operation ahead.

Standard:

12. Vehicle hazard warning signals shall not be used instead of the vehicle's high-intensity rotating, flashing, oscillating, or strobe lights.

* See page 11 for duration definitions

Mobile Operations on Two-Lane Road (TA-17)

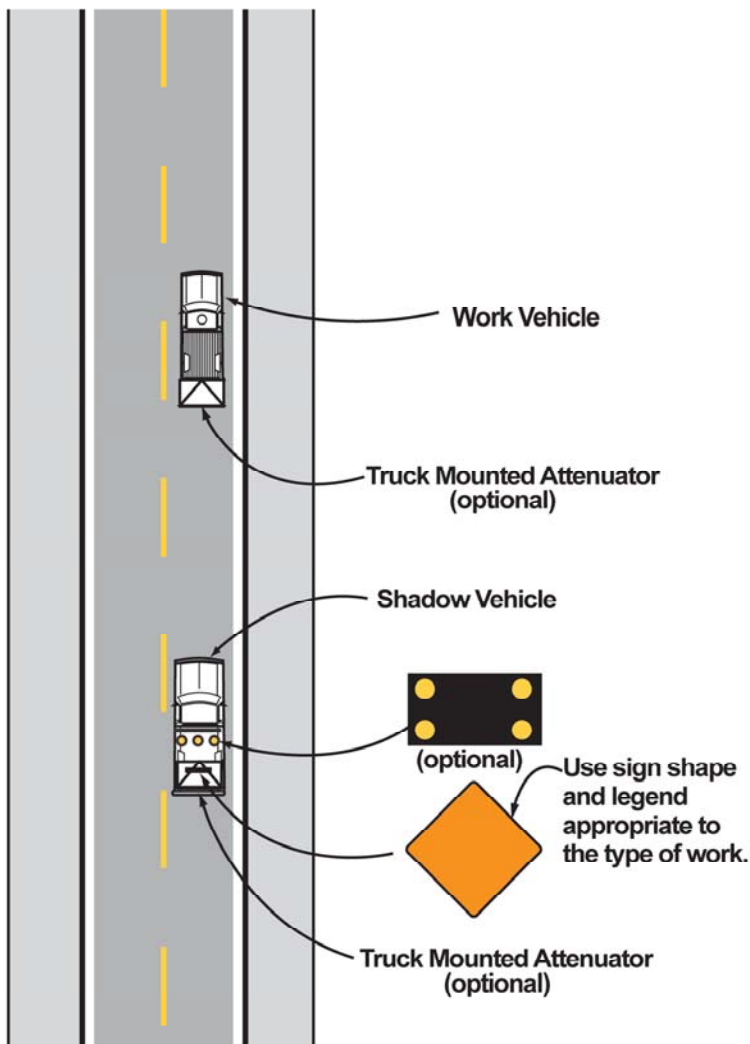

***Notes for Typical Application 18
Lane Closure on Minor Street***

Standard:

1. This TTC shall be used only for low-speed facilities having low traffic volumes.

Option:

2. Where the work space is short, where road users can see the roadway beyond, and where volume is low, vehicular traffic may be self-regulating.

Standard:

3. Where vehicular traffic cannot effectively self-regulate, one or two flaggers shall be used as illustrated in Typical Application 10.

Option:

4. Flashing warning lights and/or flags may be used to call attention to the advance warning signs.

5. A truck-mounted attenuator may be used on the work vehicle and the shadow vehicle.

Lane Closure on Minor Street (TA-18)

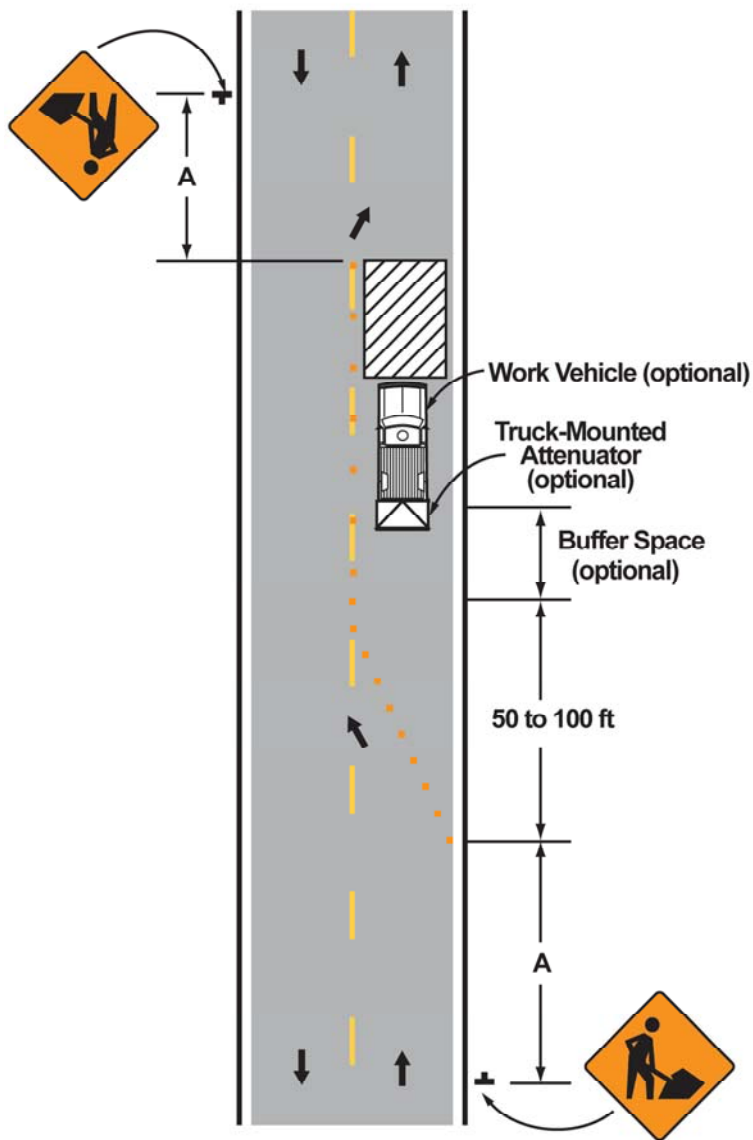

Notes for Typical Application 20
Detour for Closed Street

Guidance:

1. *This plan should be used for streets without posted route numbers.*
2. *On multi-lane streets, Detour signs with an Advance Turn Arrow should be used in advance of a turn.*

Option:

3. Flashing warning lights and/or flags may be used to call attention to the advance warning signs.
4. Flashing warning lights may be used on Type 3 Barricades.
5. Detour signs may be located on the far side of intersections. A Detour sign with an advance arrow may be used in advance of a turn.
6. A Street Name sign may be mounted with the Detour sign. The Street Name sign may be either white on green or black on orange.

Standard:

- 7. When used, the Street Name sign shall be placed above the Detour sign.**

Support:

8. See Typical Application 9 in the MUTCD for the information for detouring a numbered highway.

Detour for Closed Street (TA-20)

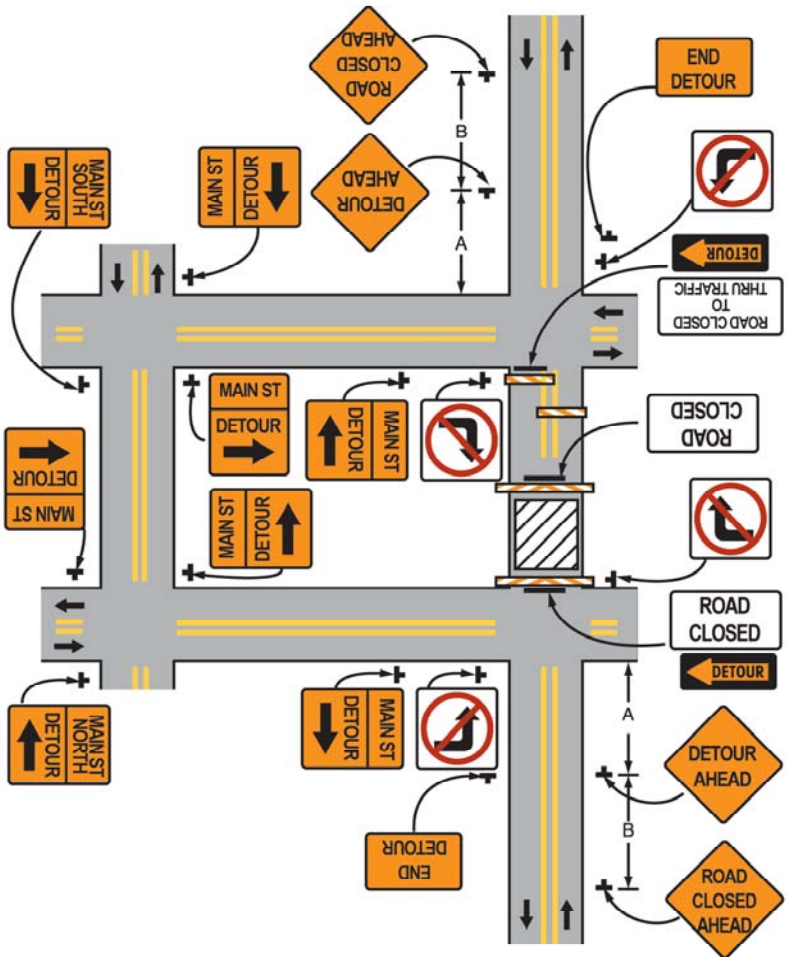

Notes for Typical Application 21
Lane Closure on Near Side of Intersection

Standard:

1. The merging taper shall direct vehicular traffic into either the right-hand or left-hand lane, but not both.

Guidance:

2. In this typical application, a left taper should be used so that right-turn movements will not impede through motor vehicle traffic. However, the reverse should be true for left-turn movements.

3. If the work space extends across a crosswalk, the crosswalk should be closed using the information and devices shown in Typical Application 29.

Option:

4. Flashing warning lights and/or flags may be used to call attention to the advance warning signs.

5. A shadow vehicle with a truck-mounted attenuator may be used.

6. A work vehicle with high-intensity rotating, flashing, oscillating, or strobe lights may be used with the high-level warning device.

7. Vehicle hazard warning signals may be used to supplement high-intensity rotating, flashing, oscillating, or strobe lights.

Standard:

8. Vehicle hazard warning signals shall not be used instead of the vehicle's high-intensity rotating, flashing, oscillating, or strobe lights.

Lane Closure on Near Side of Intersection (TA-21)

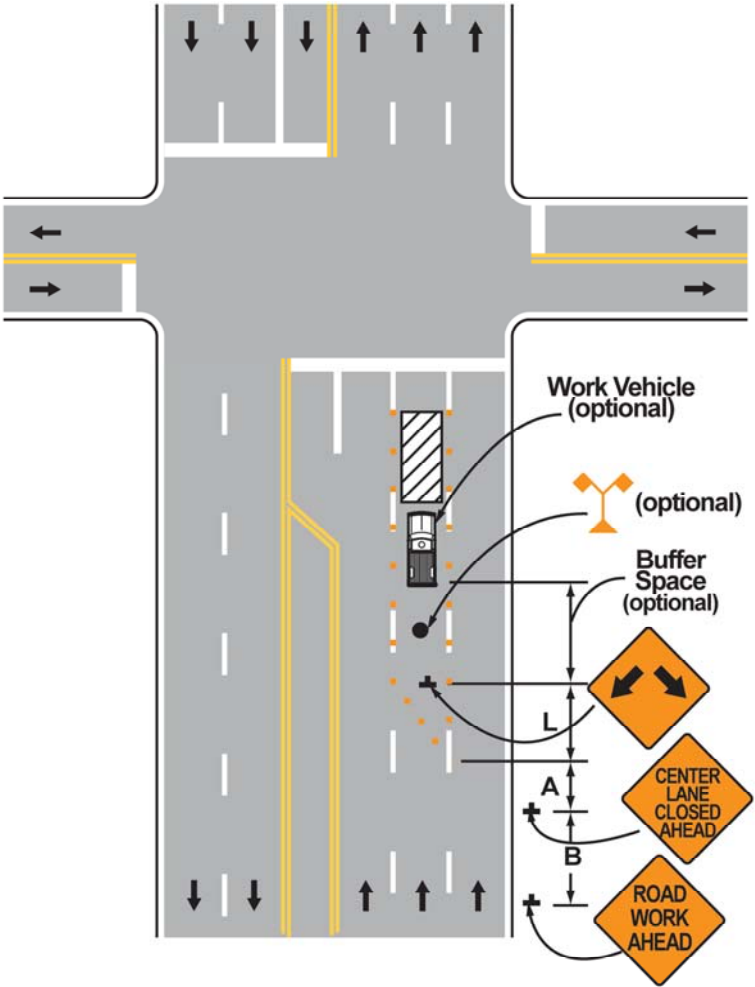

Notes for Typical Application 22
Right Lane Closure on Far Side of Intersection

Guidance:

1. *If the work space extends across a crosswalk, the crosswalk should be closed using the information and devices shown in Typical Application 29.*

Option:

2. The normal procedure is to close on the near side of the intersection any lane that is not carried through the intersection. However, when this results in the closure of a right-hand lane having significant right turning movements, then the right-hand lane may be restricted to right turns only, as shown. This procedure increases the through capacity by eliminating right turns from the open through lane.

3. For intersection approaches reduced to a single lane, left-turning movements may be prohibited to maintain capacity for through vehicular traffic.

4. Flashing warning lights and/or flags may be used to call attention to the advance warning signs.

5. Where the turning radius is large, it may be possible to create a right-turn island using channelizing devices or pavement markings.

Right Lane Closure on Far Side of Intersection (TA-22)

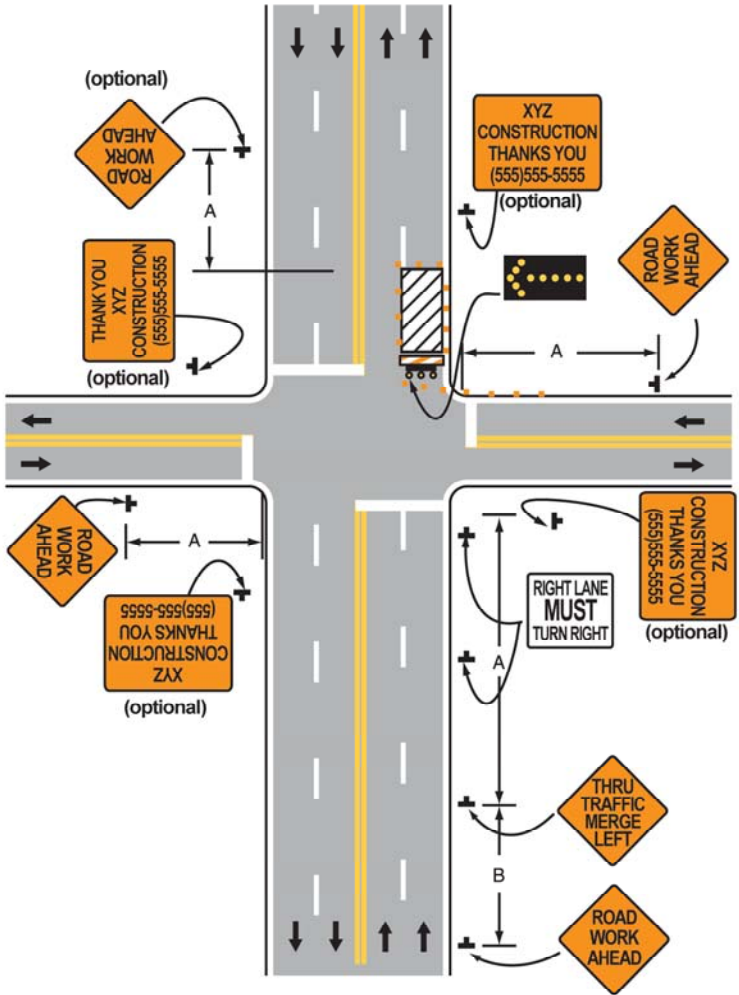

Notes for Typical Application 23
Left Lane Closure on Far Side of Intersection

Guidance:

1. If the work space extends across a crosswalk, the crosswalk should be closed using the information and devices shown in Typical Application 29.

Option:

2. Flashing warning lights and/or flags may be used to call attention to the advance warning signs.

3. The normal procedure is to close on the near side of the intersection any lane that is not carried through the intersection. However, when this results in the closure of a left lane having significant left-turning movements, then the left lane may be reopened as a turn bay for left turns only, as shown.

Support:

4. By first closing off the left lane and then reopening it as a turn bay, the left-turn bay allows storage of turning vehicles so that the movement of through traffic is not impeded. A left-turn bay that is long enough to accommodate all turning vehicles during a traffic signal cycle will provide the maximum benefit for through traffic. Also, an island is created with channelizing devices that allows the LEFT LANE MUST TURN LEFT sign to be repeated on the left adjacent to the lane that it controls.

Left Lane Closure on Far Side of Intersection (TA-23)

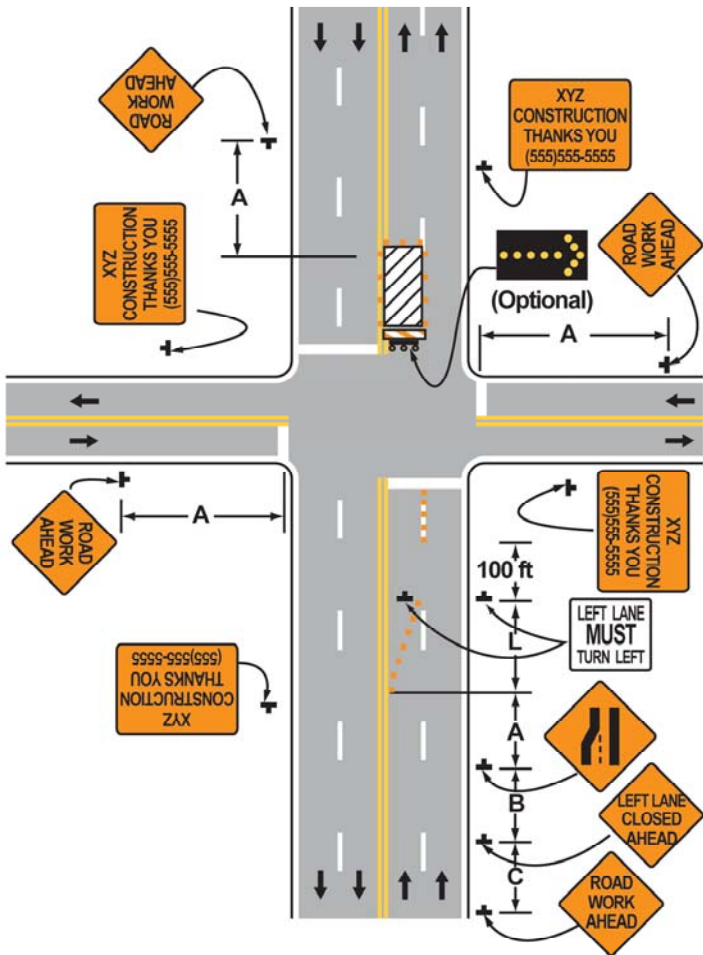

Notes for Typical Application 25
Multiple Lane Closures at Intersection

Guidance:

1. *If the work space extends across a crosswalk, the crosswalk should be closed using the information and devices shown in Typical Application 29.*

2. *If the left through lane is closed on the near-side approach, the LEFT LANE MUST TURN LEFT sign should be placed in the median to discourage through vehicular traffic from entering the left-turn bay.*

Support:

3. The normal procedure is to close on the near side of the intersection any lane that is not carried through the intersection.

Option:

4. If the left-turning movement that normally uses the closed turn bay is small and/or the gaps in opposing vehicular traffic are frequent, left turns may be permitted on that approach.

5. Flashing warning lights and/or flags may be used to call attention to the advance warning signs.

Multiple Lane Closures at Intersection (TA-25)

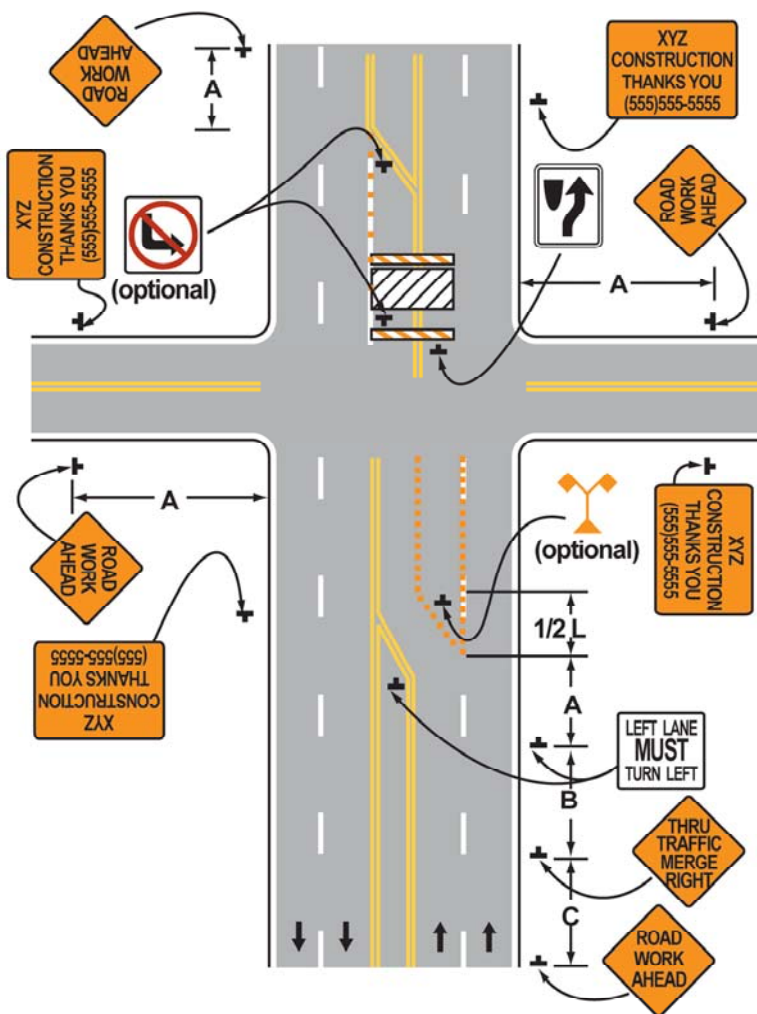

Notes for Typical Application 27 Closure at Side of Intersection

Guidance:

1. *The situation depicted can be simplified by closing one or more of the intersection approaches. If this cannot be done, and/or when capacity is a problem, through vehicular traffic should be directed to other roads or streets.*
2. *Depending on road user conditions, flagger(s) or uniformed law enforcement officer(s) should be used to direct road users within the intersection.*

Standard:

- 3. At night, flagger stations shall be illuminated, except in emergencies.**

Option:

4. Flashing warning lights and/or flags may be used to call attention to the advance warning signs.
5. For short-duration* work operations, the channelizing devices may be eliminated if a vehicle displaying high-intensity rotating, flashing, oscillating, or strobe lights is positioned in the work space.
6. A BE PREPARED TO STOP sign may be added to the sign series.

Guidance:

7. *When used, the BE PREPARED TO STOP sign should be located before the Flagger symbol sign.*
8. *ONE LANE ROAD AHEAD signs may also be used to provide adequate advance warning.*

Support:

9. Turns can be prohibited as required by vehicular traffic conditions. Unless the streets are wide, it might be physically impossible to make certain turns, especially for large vehicles.

Option:

10. Vehicle hazard warning signals may be used to supplement high-intensity rotating, flashing, oscillating, or strobe lights.

Standard:

- 11. Vehicle hazard warning signals shall not be used instead of the vehicle's high-intensity rotating, flashing, oscillating, or strobe lights.**

* See page 11 for duration definitions

Closure at Side Intersection (TA-27)

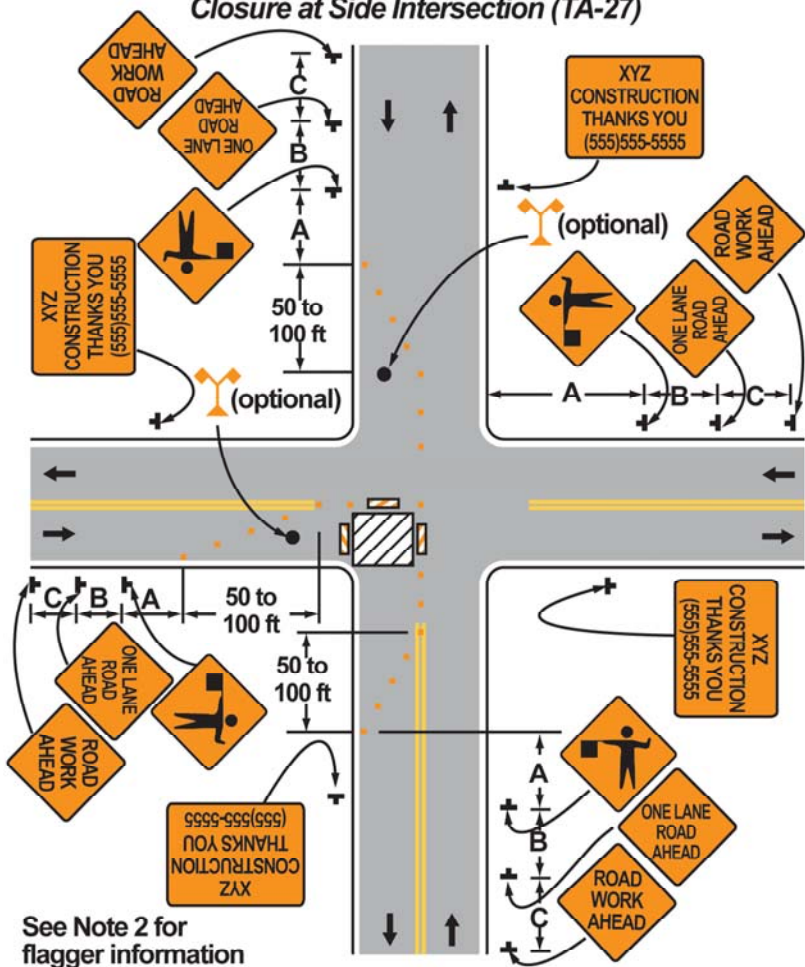

Notes for Typical Application 28
Sidewalk Detour or Diversion

Standard:

1. When crosswalks or other pedestrian facilities are closed or relocated, temporary facilities shall be detectable and shall include accessibility features consistent with the features present in the existing pedestrian facility.

Guidance:

2. Where high speeds are anticipated, a temporary traffic barrier and, if necessary, a crash cushion should be used to separate the temporary sidewalks from vehicular traffic.

3. Audible information devices should be considered where midblock closings and changed crosswalk areas cause inadequate communication to be provided to pedestrians who have visual disabilities.

Option:

4. Street lighting may be considered.

5. Only the TTC devices related to pedestrians are shown. Other devices, such as lane closure signing or ROAD NARROWS signs, may be used to control vehicular traffic.

6. For nighttime closures, Type A Flashing warning lights may be used on barricades that support signs and close sidewalks.

7. Type C Steady-Burn or Type D 360-degree Steady-Burn warning lights may be used on channelizing devices separating the temporary sidewalks from vehicular traffic flow.

8. Signs, such as KEEP RIGHT (LEFT), may be placed along a temporary sidewalk to guide or direct pedestrians.

Sidewalk Detour or Diversion (TA-28)

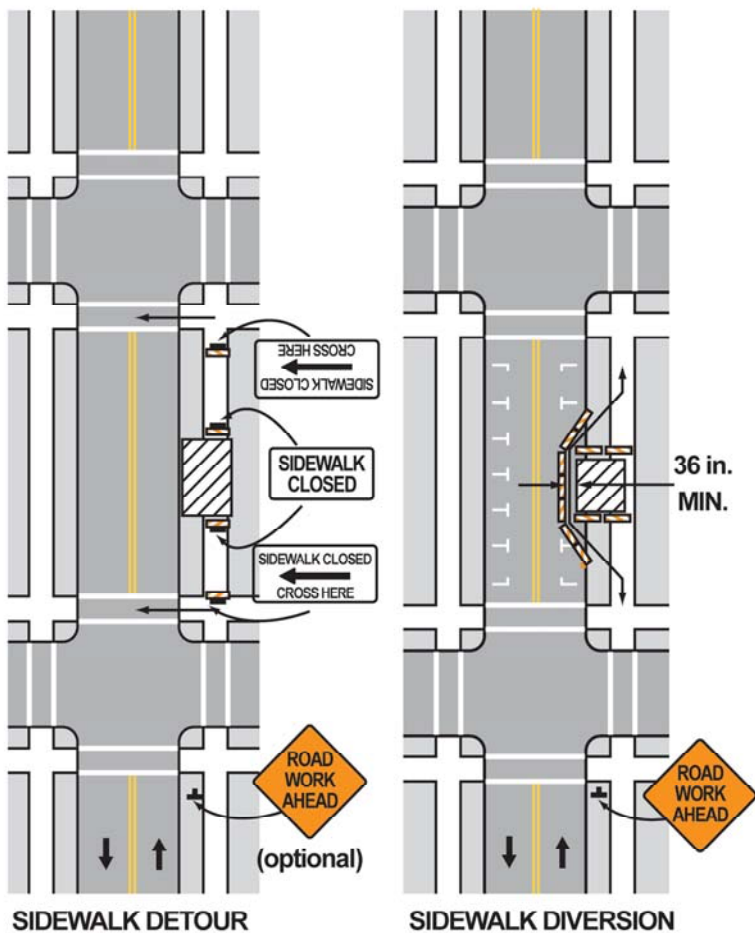

Notes for Typical Application 29
Crosswalk Closures and Pedestrian Detours

Standard:

- 1. When crosswalks or other pedestrian facilities are closed or relocated, temporary facilities shall be detectable and shall include accessibility features consistent with the features present in the existing pedestrian facility.**
- 2. Curb parking shall be prohibited for at least 50 feet in advance of the midblock crosswalk.**

Guidance:

- 3. Audible information devices should be considered where midblock closings and changed crosswalk areas cause inadequate communication to be provided to pedestrians who have visual disabilities.*
- 4. Pedestrian traffic signal displays controlling closed crosswalks should be covered or deactivated.*

Option:

- 5. Street lighting may be considered.**
- 6. Only the TTC devices related to pedestrians are shown. Other devices, such as lane closure signing or ROAD NARROWS signs, may be used to control vehicular traffic.**
- 7. For nighttime closures, Type A Flashing warning lights may be used on barricades supporting signs and closing sidewalks.**
- 8. Type C Steady-Burn or Type D 360-degree Steady-Burn warning lights may be used on channelizing devices separating the work space from vehicular traffic.**
- 9. In order to maintain the systematic use of the fluorescent yellow-green background for pedestrian, bicycle, and school warning signs in a jurisdiction, the fluorescent yellow-green background for pedestrian, bicycle, and school warning signs may be used in TTC zones.**

Crosswalk Closures and Pedestrian Detours (TA-29)

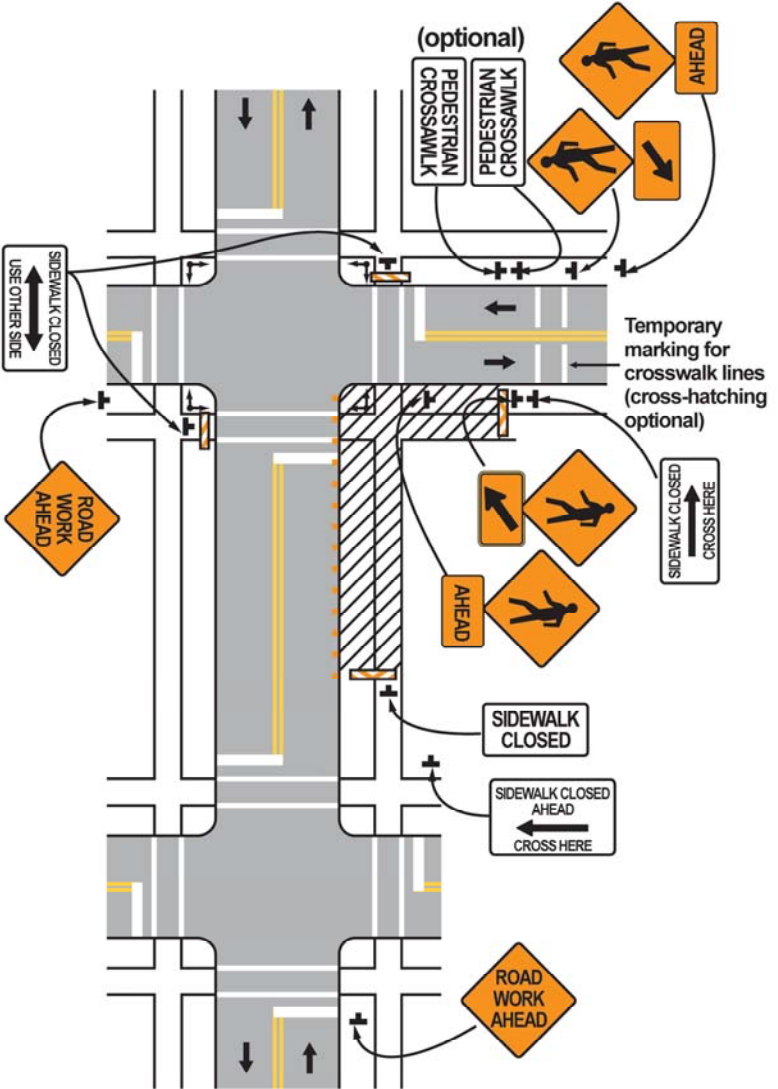

Notes for Typical Application 30
Interior Lane Closure on Multilane Street

Guidance:

1. *This information applies to low-speed, low-volume urban streets. Where speed or volume is higher, additional signing such as LEFT LANE CLOSED XX FT should be used between the signs shown.*

Option:

2. The closure of the adjacent interior lane in the opposing direction may not be necessary, depending upon the activity being performed and the work space needed for the operation.

3. Shadow vehicles with a truck-mounted attenuator may be used.

Interior Lane Closure on Multilane Street (TA-30)

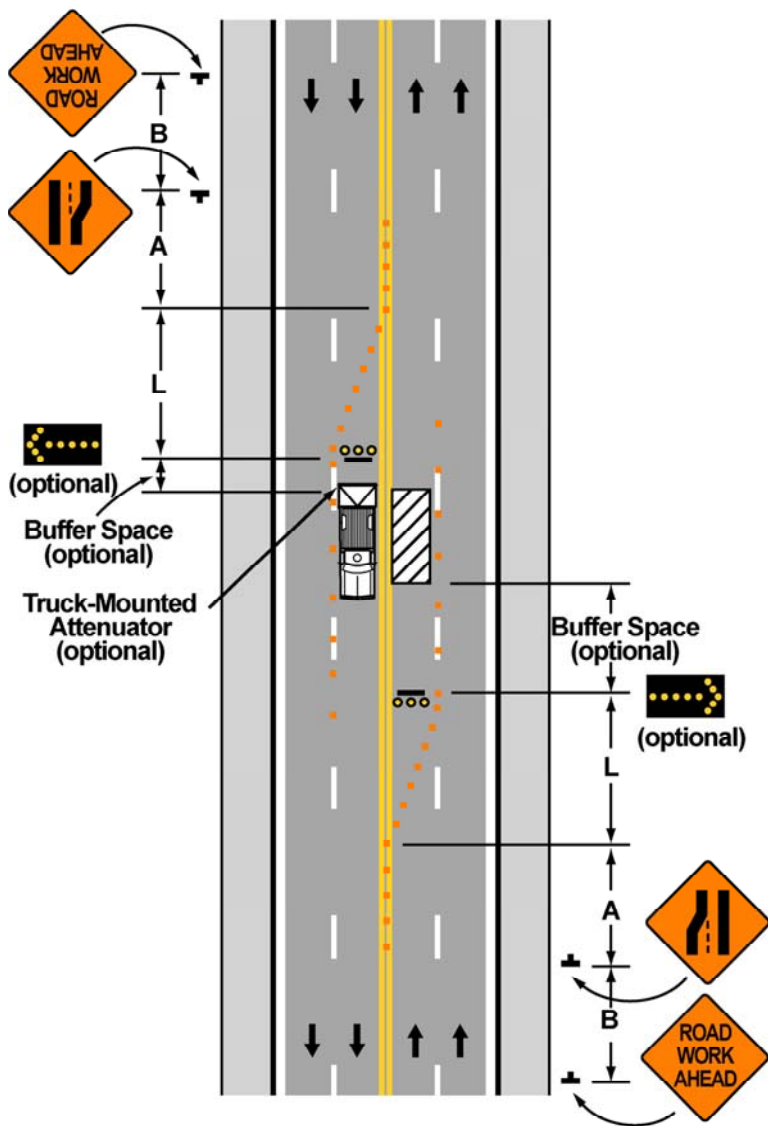

Notes for Typical Application 33
Stationary Lane Closure on Divided Highway

Standard:

- 1. This information also shall be used when work is being performed in the lane adjacent to the median on a divided highway. In this case, the LEFT LANE CLOSED signs and the corresponding Lane Ends signs shall be substituted.**
- 2. When a side road intersects the highway within the TTC zone, additional TTC devices shall be placed as needed.**

Guidance:

- 3. When paved shoulders having a width of 8 feet or more are closed, channelizing devices should be used to close the shoulder in advance of the merging taper to direct vehicular traffic to remain within the traveled way.*

Option:

- 4. A truck-mounted attenuator may be used on the work vehicle and/or shadow vehicle.**

Support:

- 5. Where conditions permit, restricting all vehicles, equipment, workers, and their activities to one side of the roadway might be advantageous.**

Standard:

- 6. An arrow panel shall be used when a freeway lane is closed. When more than one freeway lane is closed, a separate arrow panel shall be used for each closed lane.**

Stationary Lane Closure on Divided Highway (TA-33)

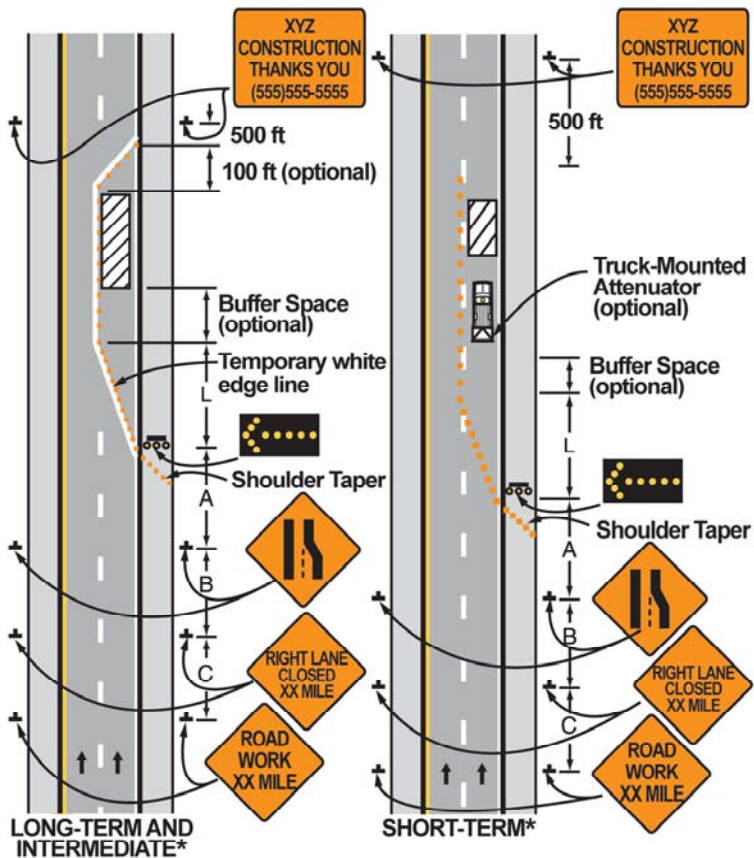

*See page 11 for duration definitions

Notes for Typical Application 35
Mobile* Operation on Multilane Road

Standard:

1. Arrow panels shall, as a minimum, be Type B, with a size of 60 x 30 in.
2. Vehicle-mounted signs shall be mounted in a manner such that they are not obscured by equipment or supplies. Sign legends on vehicle-mounted signs shall be covered or turned from view when work is not in progress.
3. Shadow and work vehicles shall display high-intensity rotating, flashing, oscillating, or strobe lights.
4. An arrow panel shall be used when a freeway lane is closed. When more than one freeway lane is closed, a separate arrow panel shall be used for each closed lane.

Guidance:

5. *Vehicles used for these operations should be made highly visible with appropriate equipment, such as flags, signs, or arrow panels.*
6. *Shadow Vehicle 1 should be equipped with an arrow panel and truck-mounted attenuator.*
7. *Shadow Vehicle 2 should be equipped with an arrow panel. An appropriate lane closure sign should be placed on Shadow Vehicle 2 so as not to obscure the arrow panel.*
8. *Shadow Vehicle 2 should travel at a varying distance from the work operation so as to provide adequate sight distance for vehicular traffic approaching from the rear.*
9. *The spacing between the work vehicles and the shadow vehicles, and between each shadow vehicle should be minimized to deter road users from driving in between.*
10. *Work should normally be accomplished during off-peak hours.*
11. *When the work vehicle occupies an interior lane (a lane other than the far right or far left) of a directional roadway having a right-hand shoulder 10 feet or more in width, Shadow Vehicle 2 should drive the right-hand shoulder with a sign indicating that work is taking place in the interior lane.*

Option:

12. A truck-mounted attenuator may be used on Shadow Vehicle 2.
13. On high-speed roadways, a third shadow vehicle (not shown) may be used with Shadow Vehicle 1 in the closed lane, Shadow Vehicle 2 straddling the edge line, and Shadow Vehicle 3 on the shoulder.
14. Where adequate shoulder width is not available, Shadow Vehicle 3 may also straddle the edge line.

* See page 11 for duration definitions

Mobile Operation on Multi-Lane Road (TA-35)

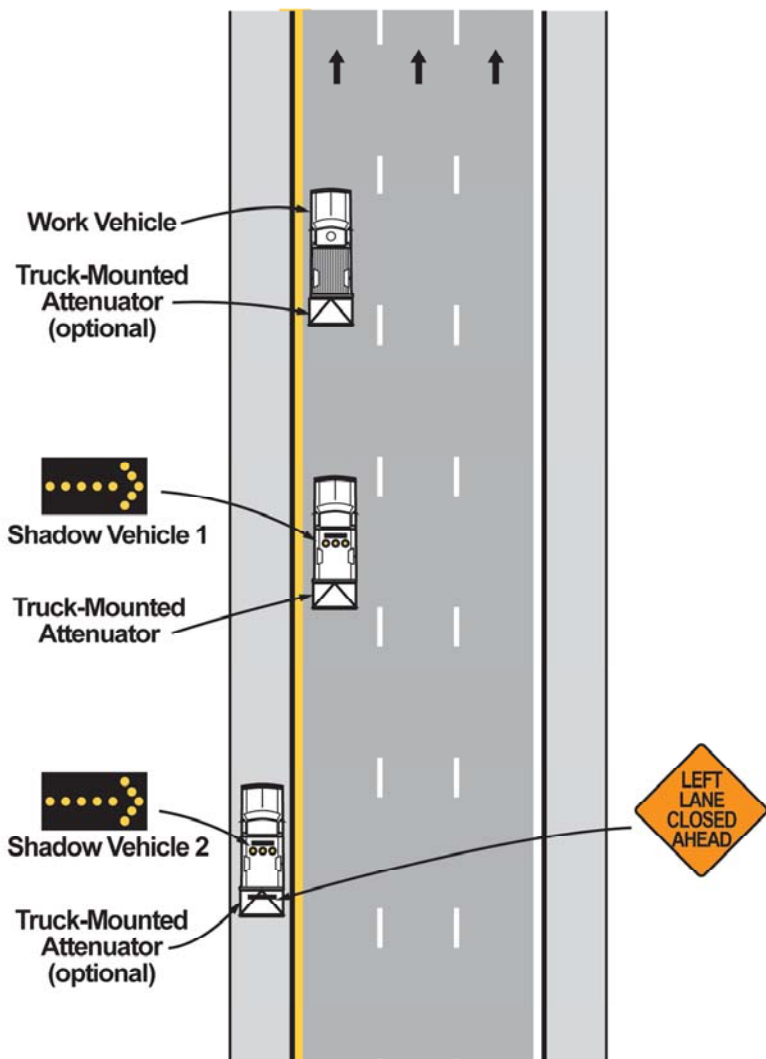

Notes for Typical Application 37
Double Lane Closure on Freeway

Standard:

1. An arrow panel shall be used when a freeway lane is closed. When more than one freeway lane is closed, a separate arrow panel shall be used for each closed lane.

Guidance:

2. Ordinarily, the preferred position for the second arrow panel is in the closed exterior lane at the upstream end of the second merging taper. However, the second arrow panel should be placed in the closed interior lane at the downstream end of the second merging taper in the following situations:

- a. When a shadow vehicle is used in the interior closed lane, and the second arrow panel is mounted on the shadow vehicle;
- b. If alignment or other conditions create any confusion as to which lane is closed by the second arrow panel; and
- c. When the first arrow panel is placed in the closed exterior lane at the downstream end of the first merging taper (the alternative position when the shoulder is narrow).

Option:

3. Flashing warning lights and/or flags may be used to call attention to the initial warning signs.

4. A truck-mounted attenuator may be used on the shadow vehicle.

5. If a paved shoulder having a minimum width of 10 feet and sufficient strength is available, the left and adjacent interior lanes may be closed and vehicular traffic carried around the work space on the right-hand lane and a right-hand shoulder.

Guidance:

6. When a shoulder lane is used that cannot adequately accommodate trucks, trucks should be directed to use the normal travel lanes.

Double Lane Closure on Freeway (TA-37)

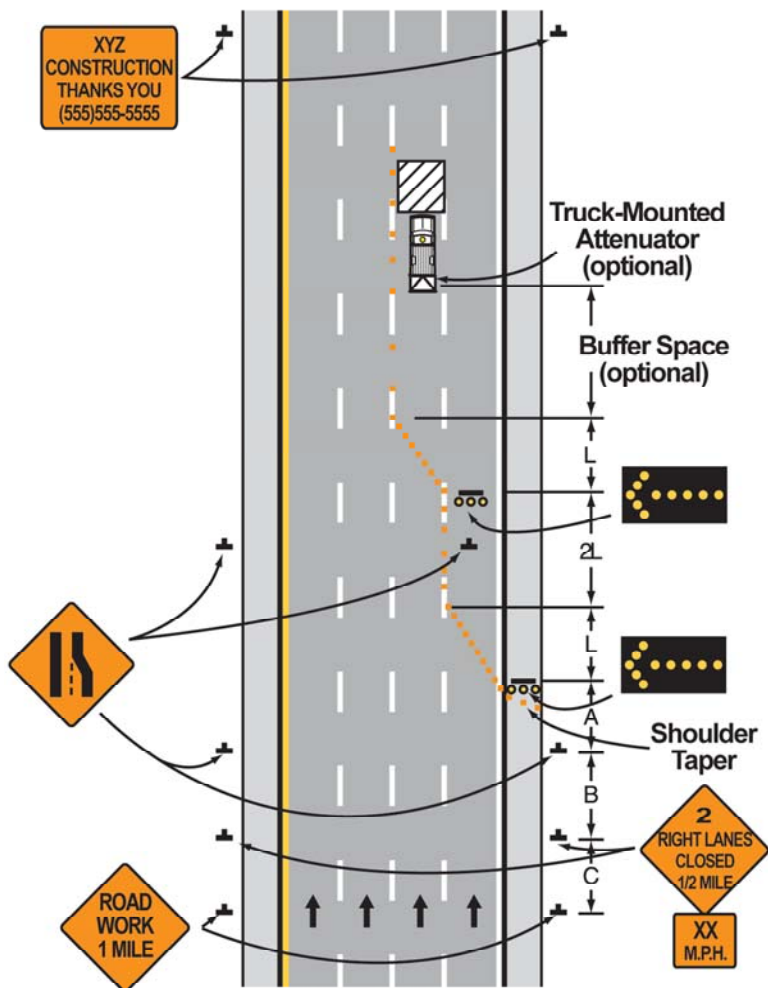

**Notes for Typical Application 42
Work in Vicinity of Exit Ramp**

Guidance:

- 1. The guide signs should indicate that the ramp is open, and where the temporary ramp is located. However, if the ramp is closed, guide signs should indicate that the ramp is closed.*
- 2. When the exit ramp is closed, a black on orange EXIT CLOSED sign panel should be placed diagonally across the interchange/intersection guide signs.*
- 3. The design criteria contained in the AASHTO "Policy on the Geometric Design of Highways and Streets" (see Section 1A.11 of the MUTCD) should be used for determining the alignment.*

Standard:

- 4. A temporary EXIT sign shall be located in the temporary gore. For better visibility, it shall be mounted a minimum of 7 feet from the pavement surface to the bottom of the sign.**

Option:

- 5. The temporary EXIT sign placed in the temporary gore may be either black on orange or white on green.*
- 6. An alternative procedure that may be used is to channelize exiting vehicular traffic onto the right-hand shoulder and close the lane as necessary.*

Standard:

- 7. An arrow panel shall be used when a freeway lane is closed. When more than one freeway lane is closed, a separate arrow panel shall be used for each closed lane.**

Work in Vicinity of Exit Ramp (TA-42)

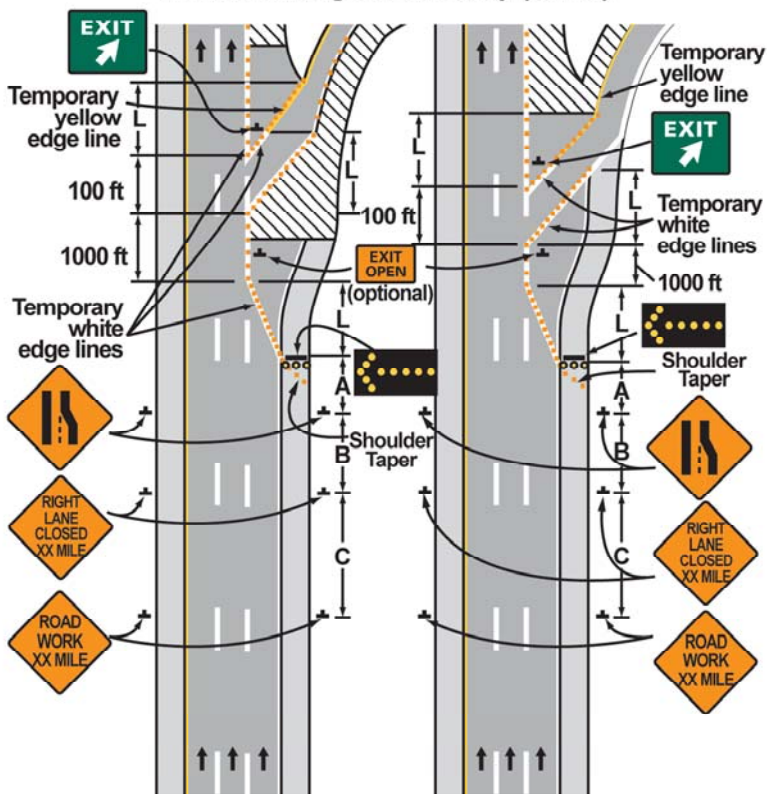

Notes for Typical Application 43
Partial Exit Ramp Closure

Guidance:

1. *Truck off-tracking should be considered when determining whether the minimum lane width of 10 feet is adequate (see Section 6G.08 of the MUTCD).*

Partial Exit Ramp Closure (TA-43)

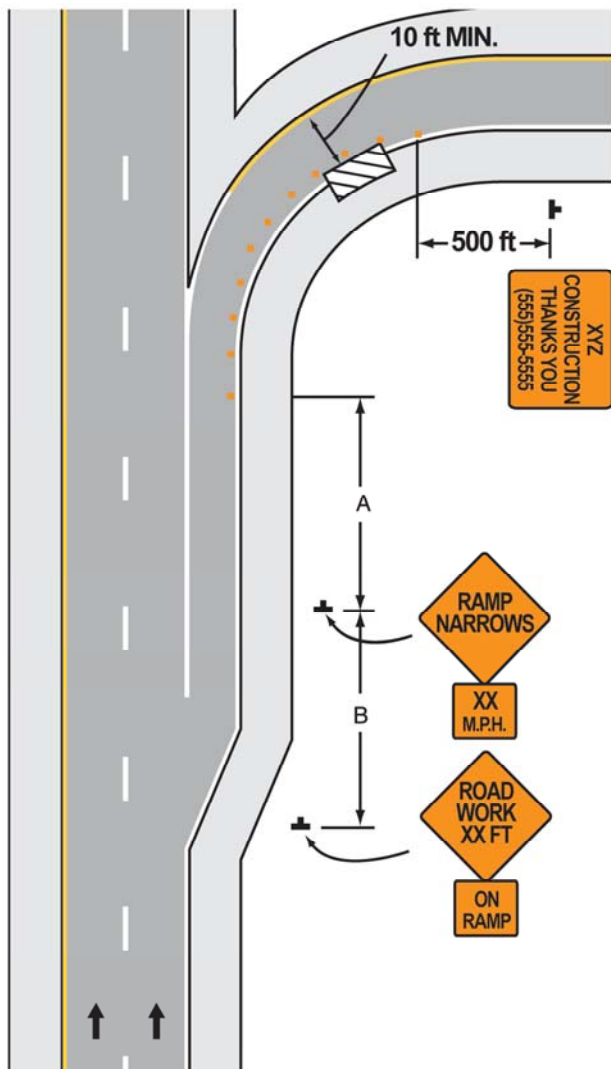

Notes for Typical Application 46 Work in Vicinity of a Grade Crossing

Guidance:

1. *When grade crossings exist either within or in the vicinity of roadway work activities, extra care should be taken to minimize the probability of conditions being created, by lane restrictions, flagging, or other operations, where vehicles might be stopped within the grade crossing, considered as being 15 feet on either side of the closest and farthest rail.*

Standard:

2. If the queuing of vehicles across active rail tracks cannot be avoided, a uniformed law enforcement officer or flagger shall be provided at the grade crossing to prevent vehicles from stopping within the grade crossing (as described in Note 1), even if automatic warning devices are in place.

Guidance:

3. *Early coordination with the railroad company or light rail transit agency should occur before work starts.*

4. *In the example depicted, the buffer space of the activity area should be extended upstream of the grade crossing (as shown) so that a queue created by the flagging operation will not extend across the grade crossing.*

5. *The DO NOT STOP ON TRACKS sign should be used on all approaches to a grade crossing within the limits of a TTC zone.*

Option:

6. *Flashing warning lights and/or flags may be used to call attention to the advance warning signs.*

7. *A BE PREPARED TO STOP sign may be added to the sign series.*

Guidance:

8. *When used, the BE PREPARED TO STOP sign should be located before the Flagger symbol sign.*

Standard:

9. At night, flagger stations shall be illuminated, except in emergencies.

Work in the Vicinity of a Grade Crossing (TA-46)

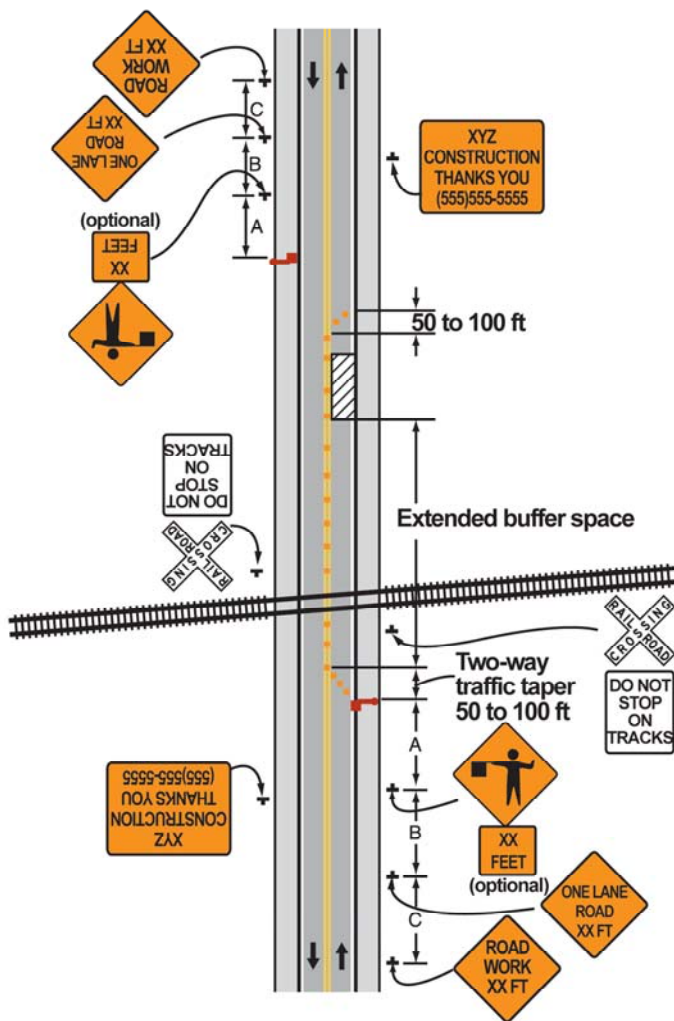

*Center Turn Lane Closed on a
Three-lane Two-way Road (CO-1)*

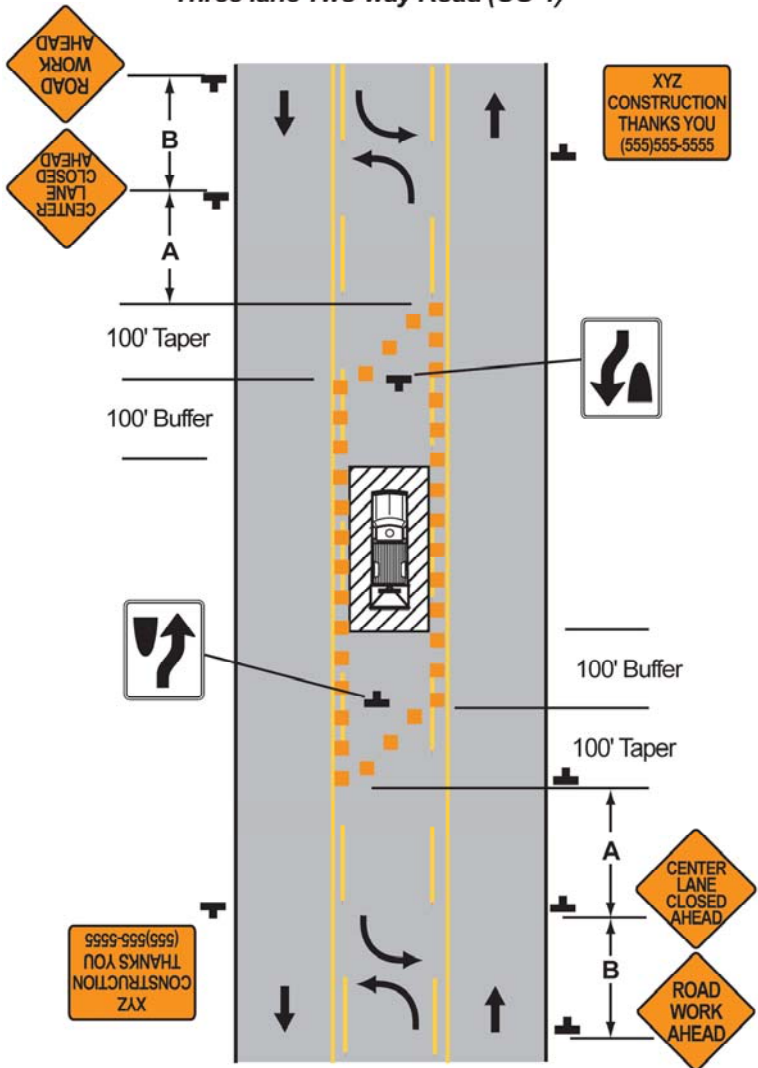

Lane Shift on a Three-lane Two-way Road (CO-2)

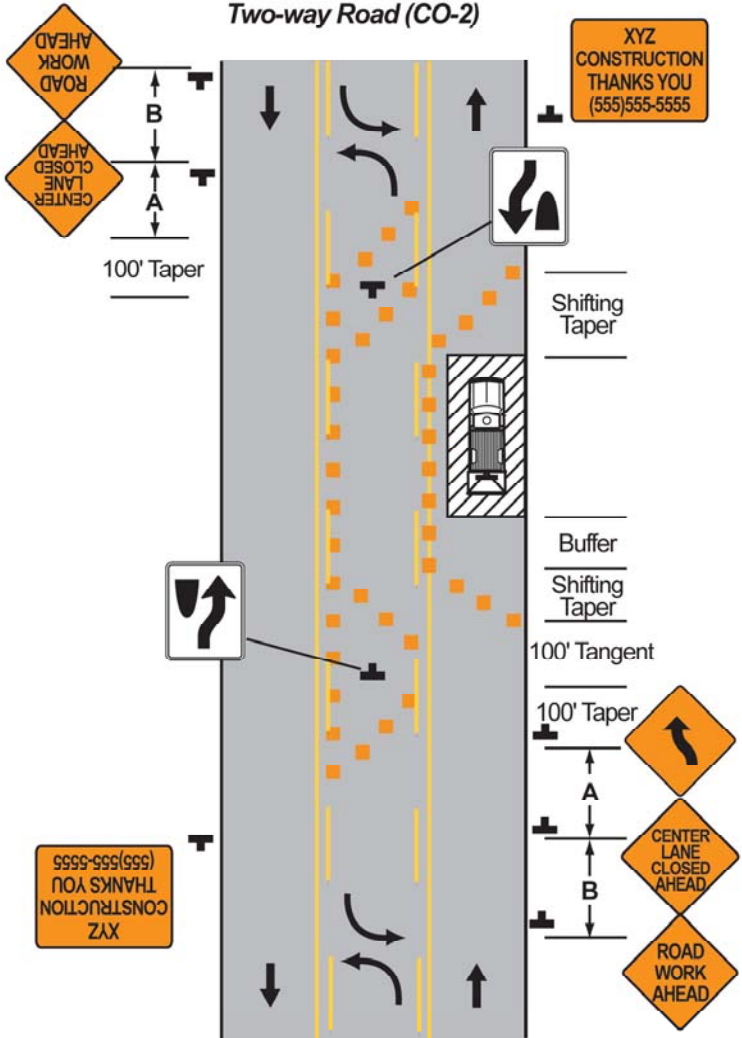

Nighttime Typical Applications

Adapted From NCHRP Report 476

**“Guidelines for Design and Operation of
Nighttime Traffic Control for Highway
Maintenance and Construction”**

NWTA-1—LANE CLOSURE ON DIVIDED HIGHWAY FOR NIGHT WORK

See Figure NWTA-1. Refer to TA-33 for additional information.

1. A BE PREPARED TO STOP sign (W3-4) may be added if traffic is slowing excessively or stopping at the merge area— see MUTCD Table 6C-1 and Table 6H-3.
2. A portable or permanent CMS may be used to provide advance project information or driver guidance specific to the night operation.
3. Taper starting point should be located to provide good sight distance, be separated from other conflict points, and be located where roadside recovery area is available.
4. Channelizing devices are drums, 1 ft by 2 ft vertical panels, or Type 2 barricades (and 3 ft cones only in the tangent sections).
5. Channelizing device spacing in feet equals the speed limit in miles per hour, with a maximum of 40 ft. Spacing is halved at ramps, intersections, and other conflict points.
6. Where lateral buffer space is not available, a flagger or spotter may be used to protect workers close to the travel lane.
7. Where positive separation between the traffic space and work space is desirable, temporary barrier may be added.
8. Midlane devices are provided at 750 ft maximum spacing to reduce risk of intrusions when work operations permit and to mark pavement excavations. Type 3 or 2 barricades, drums, or 1 ft by 2 ft vertical panels are suitable.
9. Type A warning lights are installed on the first two channelizing devices on the taper.
10. Type B warning lights may be added to enhance the conspicuity of advance warning signs.
11. Type C arrow panel operating in the left arrow or chevron mode is placed on the shoulder at the start of the taper if space permits or farther downstream in the taper if necessary.

NWTA-1—LANE CLOSURE ON DIVIDED HIGHWAY FOR NIGHT WORK (Continued)

12. DO NOT PASS signs (R4-1) may be added throughout the closure at ½ mile spacing where long lane closures and spotty work activities may result in impatient drivers attempting to pass.
13. An intrusion alarm may be located in the longitudinal buffer space or at other locations upstream of the work operation when construction traffic will not trigger false alarms.
14. Setup and removal sequences.
 - Activate changeable message sign (CMS) with operation-specific message.
 - Advance warning signs are placed or uncovered. Workers are protected by work or police vehicles on the shoulder. Workers should not cross active traffic lanes to place signs.
 - Arrow panel is placed and activated on the shoulder, and the light tower is placed downstream from the arrow panel.
 - Channelizing devices are set in the taper working from a work vehicle with TMA. Police or work vehicles with TMA may be used to form a rolling roadblock when traffic conditions are severe.
 - Channelizing devices are set in tangent section working from work vehicle, protected by TMA or police cruiser, and midlane devices are placed.
 - Remaining signs and devices are placed using work vehicle with TMA to protect workers. Light towers are placed in the work space.
 - Removal sequence proceeds in reverse order.
15. Lane changeover sequence
 - Channelizing devices in shift area are placed on the shoulder prior to start of the changeover.
 - Police cruiser or protection vehicle with TMA delays traffic in open lane.
 - Workers relocate devices to form shift taper along each side of the travel lane while traffic is delayed.
 - Large arrow (W1-6) is placed at the start of the taper.
 - Portable light tower is set up at the start of the shift taper.
 - Traffic is allowed to proceed.
 - Removal sequence proceeds in reverse order.

Right Lane Closure (NWT-1A)

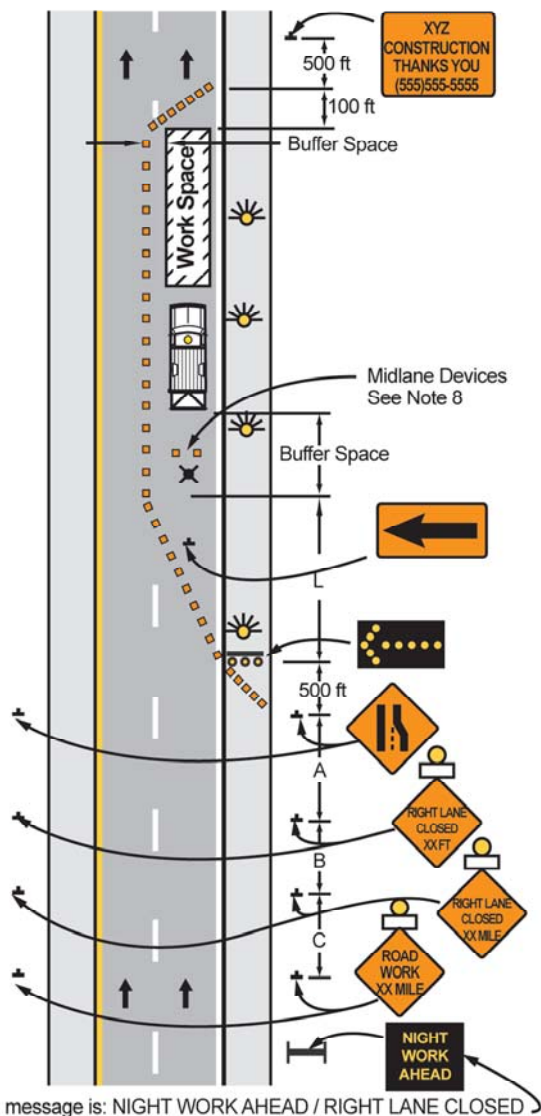

Right Lane Closure (NWT-1B)

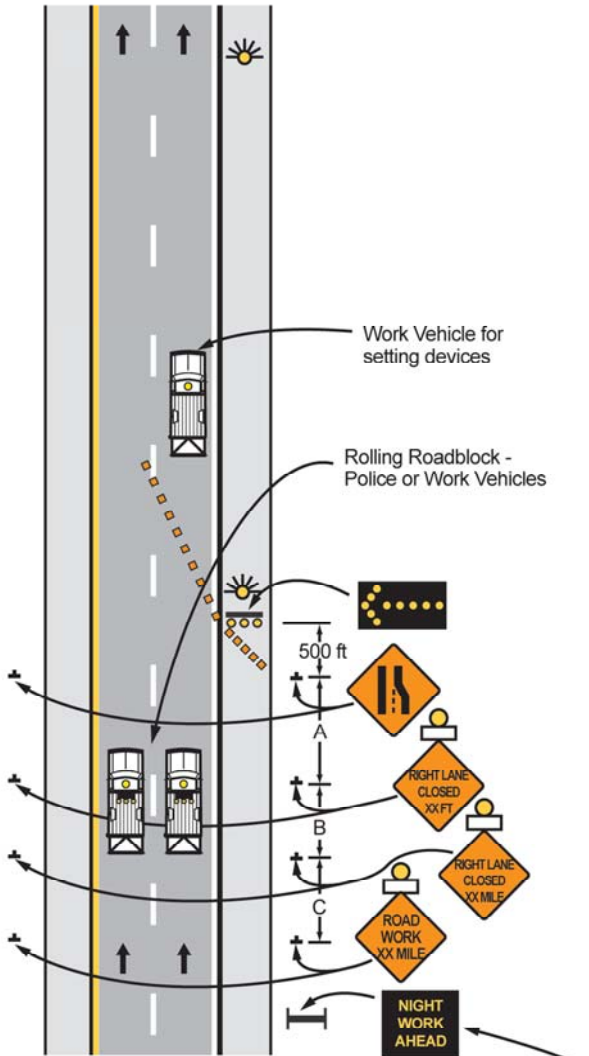

Full message is: NIGHT WORK AHEAD / RIGHT LANE CLOSED

Lane Closure Changeover (NWT-1C)

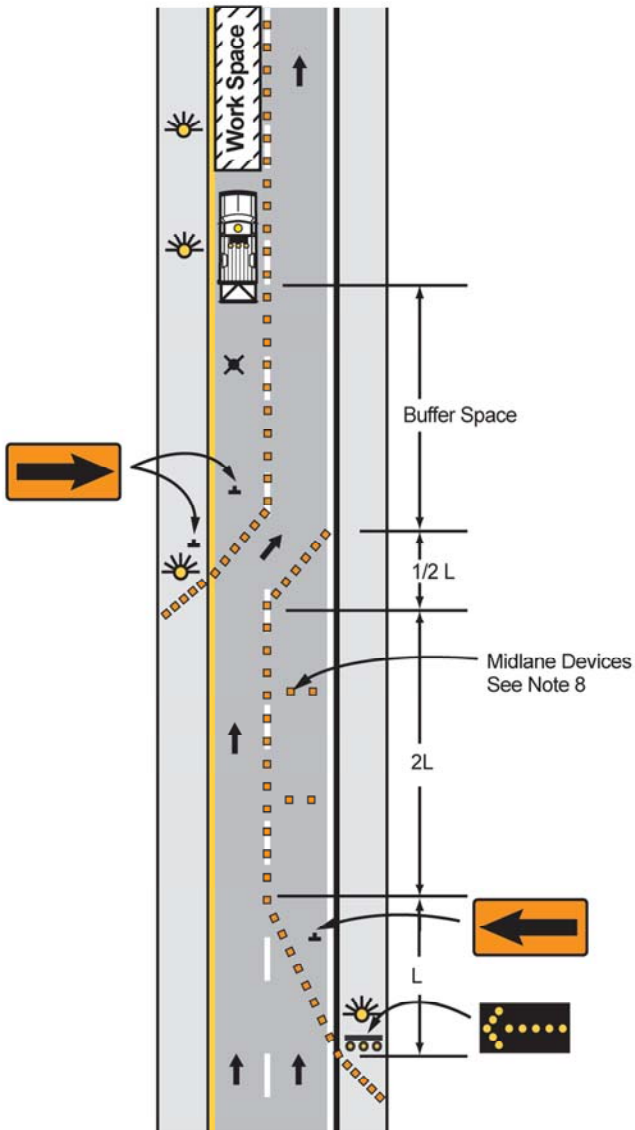

NWTA-2—FREEWAY CLOSURE FOR NIGHT WORK WITH TRAFFIC DIVERSION TO SERVICE ROAD

See Figure NWTA-2. Refer to TA-37 for additional guidance on freeway lane closures.

1. Refer to NWTA-1 for additional details on advance signing, taper details, and channelizing device type and spacing.
2. Where space permits, a distance of $2L$ is desirable between tapers to smooth flow, with a minimum of $0.5L$.
3. An arrestor net is shown for intrusion protection. Other options may be appropriate, and a watch guard or police cruiser may be used with or without the arrestor net.
4. Type A warning lights are used on the first two devices in each taper and on Type 3 barricades across the closed roadway.
5. A Type C arrow panel operating in the right arrow or chevron mode is placed on the shoulder at the start of the left-lane taper if space permits, or farther downstream in the taper if necessary. Another Type C arrow panel is placed in the center-lane taper corresponding to the placement location for the left-lane taper. No arrow panel is used for the right-lane shift.
6. Channelizing devices for the right-lane shift taper are Type 3 barricades placed in a continuous array.
7. Width of travel lane at diversion from the main line is based on geometry and expected vehicles, with a desirable maximum of 15 ft to prevent passing.
8. Detour route signs are provided on the service road from the closure to the return to the main line. TA-9 in the MUTCD shows typical detour route signing.
9. A BE PREPARED TO STOP sign (W3-4) may be added if traffic is slowing excessively or stopping at the merge area.
10. A portable or permanent CMS may be used to provide advance project information or driver guidance specific to the operation.

Freeway Closure with Traffic Diversion to Service Road (NWTa-2)

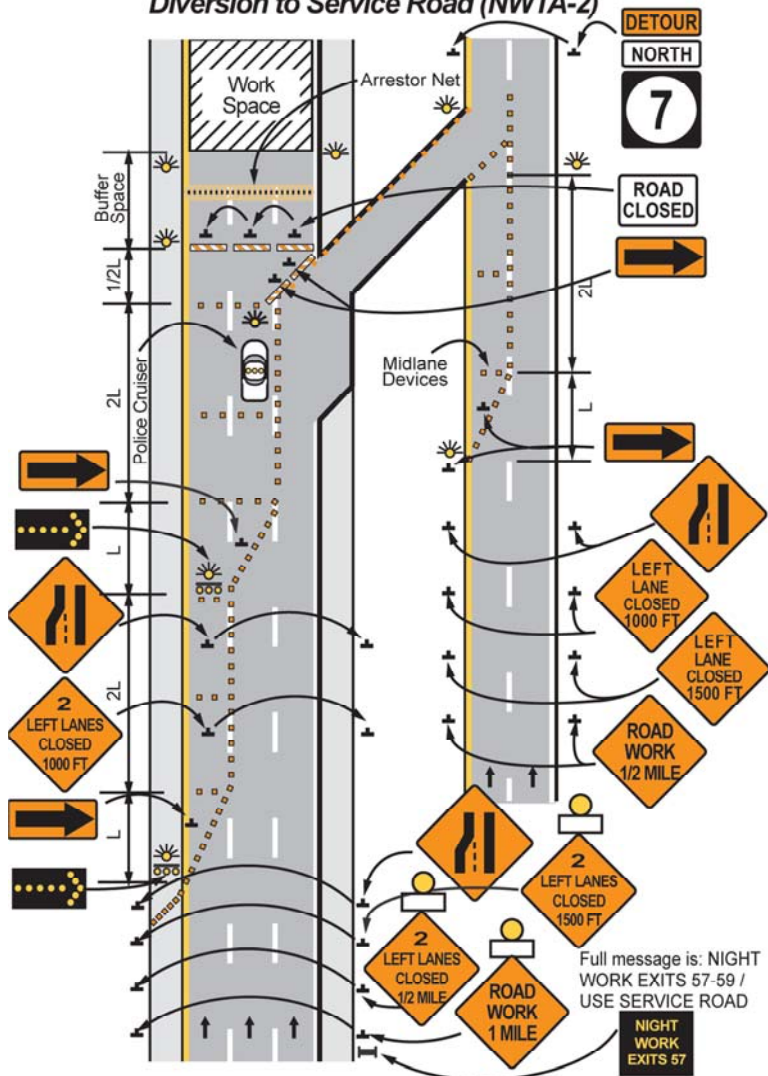

NWTA-3—ON-RAMP CLOSURES FOR NIGHT WORK

See Figure NWTA-3. Refer to TA-8 for additional information on road closures and detours.

NWTA-3A—On-ramp closure from service road:

1. A continuous array of Type 3 barricades is used to close the entrance to the ramp from the service road.
2. A second row of Type 3 barricades is placed perpendicular to the ramp downstream from the service road.
3. An advance posting distance of 500 ft is adequate for the RAMP CLOSED AHEAD sign for speeds of 45 mph or less, with additional distance provided for higher speeds.
4. Two Type A warning lights are mounted at the top of the first Type 3 barricade adjacent to the service road. Type A warning lights are spaced at approximately 4-5 ft on the barricades perpendicular to the ramp.
5. In NWTA-3A, an arrestor net is used for intrusion protection. A police cruiser or watch guard may be used with or without the arrestor. NWTA-3B shows an alternate treatment using Type 3 barricades. Truck Mounted Attenuators may be used when arrestor nets are impractical.
6. Construction traffic may be allowed to enter if a path is available around the barricades and arrestor net. The work entrance must not encourage deliberate or inadvertent intrusions.
7. RAMP CLOSED signs are placed behind the Type 3 barricades along the service road, oriented perpendicular to the service road, and above the second row of barricades, oriented perpendicular to the ramp.

On-Ramp Closure from Service Road (NWT-3A)

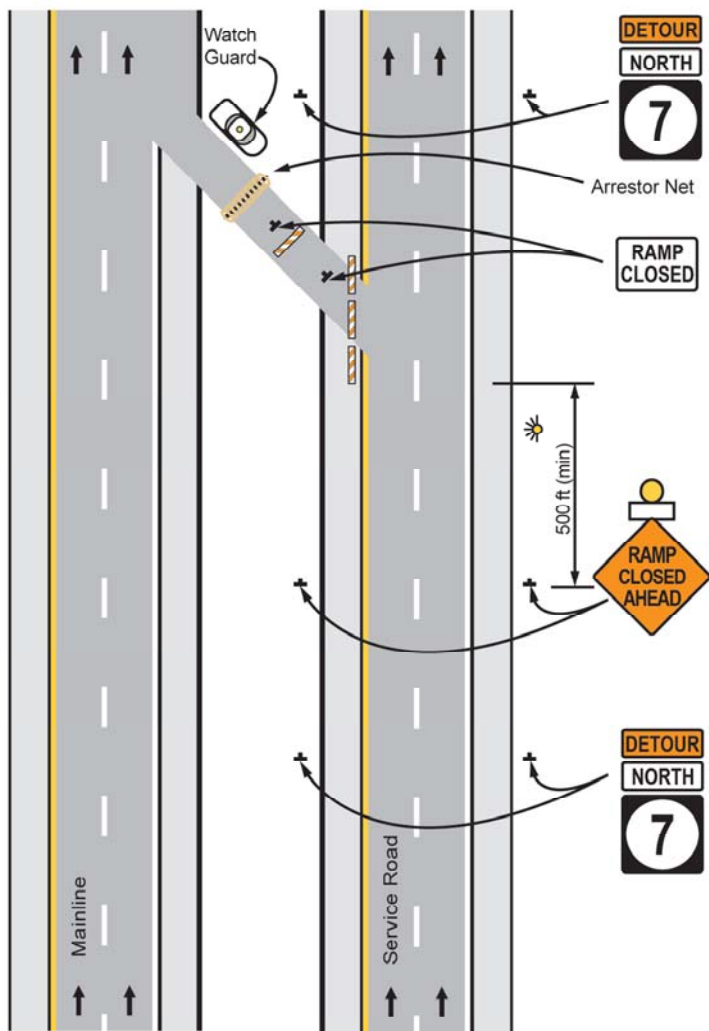

NWTA-3B—On-ramp closure from cross street:

1. An advance posting distance of 500 ft for the DETOUR AHEAD sign (W20-2) on each approach is adequate for speeds of 45 mph or less, with additional distance provided for higher speeds.
2. Type 3 barricades are placed continuously across the on-ramp to prevent entrance. Type 3 barricades are also placed across the westbound (WB) off-ramp to prevent wrong-way intrusions.
3. Type A warning lights are spaced at 4-5 ft on both sets of barricades.
4. The detour signing shown is based on the assumption that the WB expressway traffic is detoured onto the eastbound (EB) expressway to an alternate route at an exit farther east. Other detour routes should be signed appropriately.
5. In NWTA-3B, multiple rows of barricades are used for intrusion protection. A police cruiser or watch guard may be used with or without the barricades. NWTA-3A shows an alternate treatment using an arrester net. Truck Mounted Attenuators may be used when arrester nets are impractical.
6. Regulatory RAMP CLOSED signs are placed above and behind the barricades on both the on- and off ramps.
7. Two DETOUR ARROW signs (M4-10) are placed on the face of the barricades on the on-ramp.
8. Where exit lanes or turn bays are provided for the on-ramp, channelizing devices will be needed to close them as well.
9. If traffic speed and/or ramp volumes are high, or other conditions indicate the need for it, a RAMP CLOSED AHEAD (W20-3) sign may be added upstream of the DETOUR AHEAD sign.

On-Ramp Closure from Cross Street (NWT A-3B)

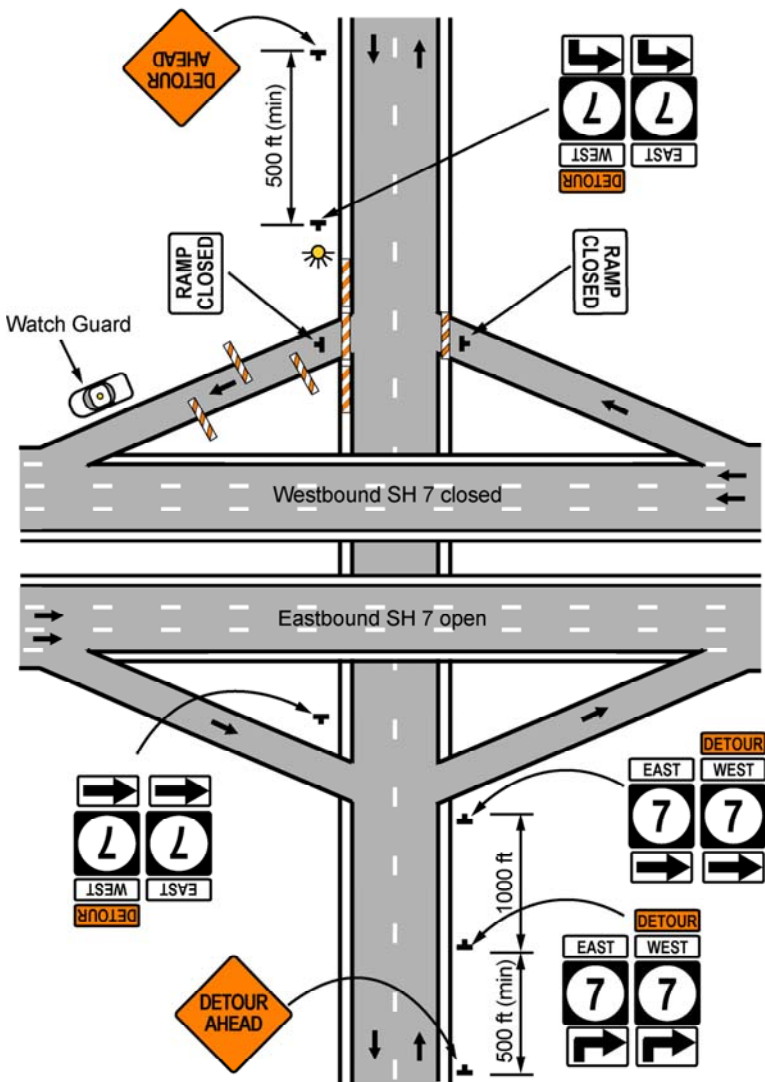

NWTA-4—FREEWAY SHOULDER CLOSURE USING TEMPORARY CONCRETE BARRIER WITH LANE CLOSURE FOR NIGHT WORK

See Figure NWTA-4. Refer to TA-5 and TA-33 for additional information on shoulder and lane closures.

1. Temporary concrete barrier (TCB) is used when long-term activities on the shoulder require positive protection.
2. NWTA-4A shows shoulder closure details for periods when the lane closure is not in place.
3. Shoulder taper length is $(1/3) L$.
4. Buffer space is shown between the downstream end of the taper and the TCB.
5. Several options are available for work vehicles to enter the closed lane, depending on site and traffic characteristics. Details for work vehicle access should be addressed in the contractor's operational plan.
6. An alternative to the setup shown is to use moveable concrete barrier. It would be positioned along the edge of the shoulder during non-work hours and shifted to close the lane during work hours.
7. If moveable barrier is used, the lane closure is installed by first setting up the lane closure advance signing and channelizing devices following the procedure in NWTA-1. Then the barrier is shifted into position. Removal proceeds in the reverse order.
8. Only the northbound (NB) roadway is shown. Traffic control may also be needed for the southbound (SB) roadway if traffic operations are affected.
9. Midlane devices should be placed at 750 ft intervals.

Shoulder Closure Non-Work Hours (NWT-4A)

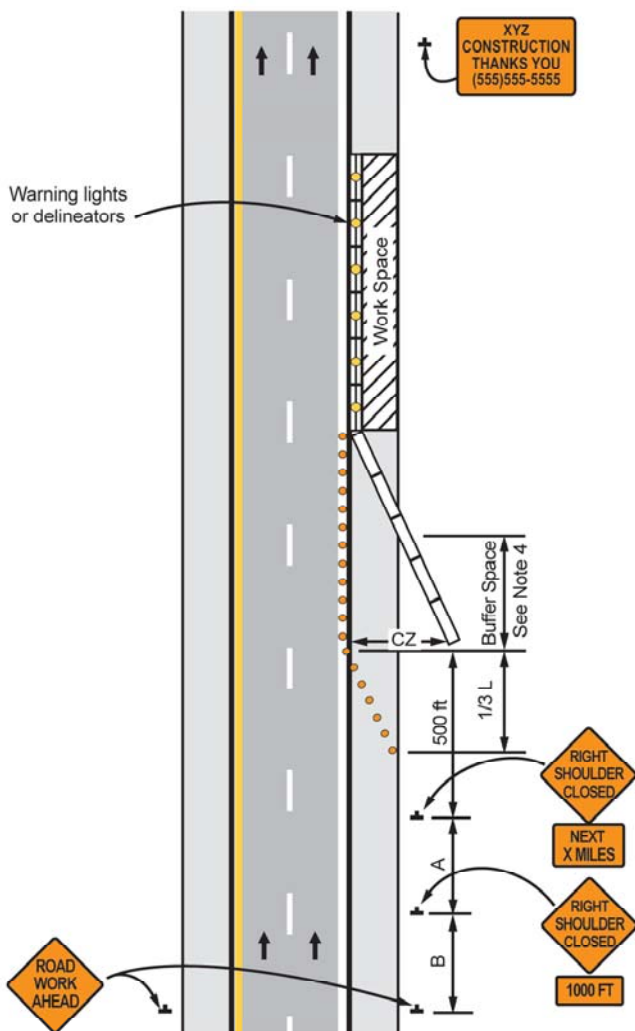

Right Lane Closed for Night Operations (NWT-4B)

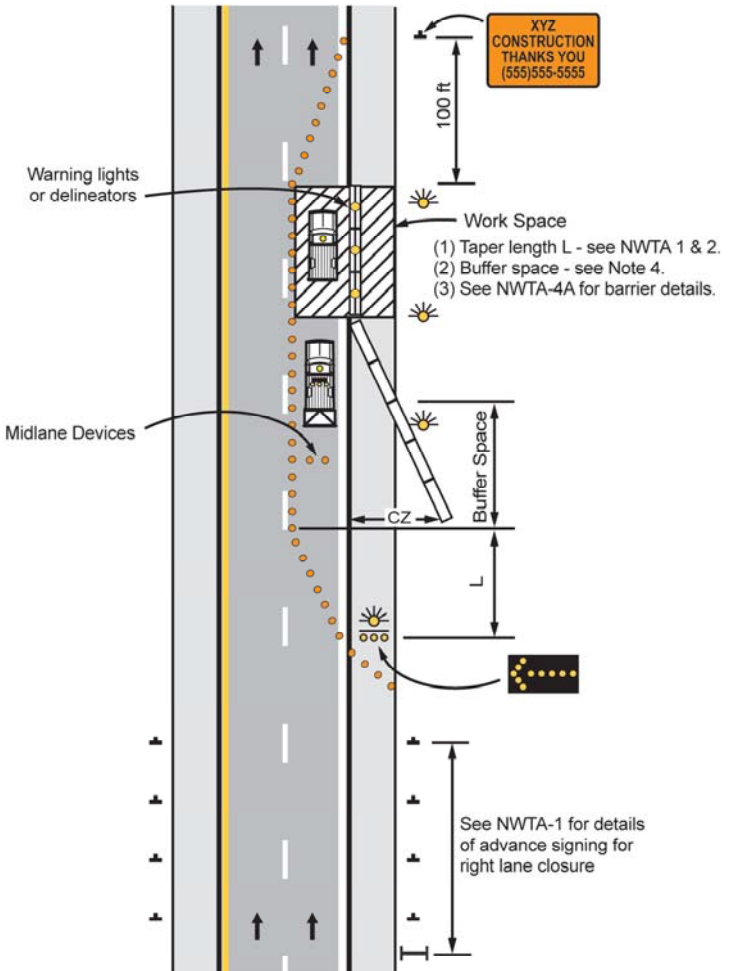

This page was intentionally left blank.

NWTA-5—FREEWAY MEDIAN CROSSOVER FOR NIGHT WORK USING MOVEABLE CONCRETE BARRIER

See Figure NWTA-5. Refer to MUTCD TA-39 and TA-45 for additional information.

1. Use of moveable barrier may be appropriate when traffic speed and volume during night work hours indicate the need for positive separation between opposing traffic streams.
2. Channelizing devices are drums, 1 ft by 2 ft vertical panels, or Type 2 barricades (and 3 ft cones only in the tangent sections).
3. Channelizing device spacing in feet equals 0.3 times the speed limit in miles per hour, with a maximum of 40 ft. Spacing is halved at ramps, intersections, and other conflict points.
4. A portable or permanent CMS may be used to provide advance project information or driver guidance specific to the night operation.
5. Where space permits, a distance of $2L$ is desirable between the NB lane closure taper and the crossover shift taper to smooth flow, with a minimum of $0.5L$.
6. Appropriate points for work vehicles to enter the work space should be identified in the contractor's operational plan.
7. Depending on the alignment and total length of the crossovers, use of either curve W1-2 or reverse curve W1-4 signs may be appropriate to alert drivers to the alignment changes.
8. The setup and removal sequence for this NWTA is as follows:
 - Install SB left-lane closure—see NWTA-1 for setup sequence.
 - Shift barrier into position downstream from the left-lane closure using the barrier transfer machine. Additional protection is not needed during the barrier shift.
 - Working from the closed SB left lane and median, place channelizing devices and signs throughout the length of the crossover.
 - Install NB right-lane closure—see NWTA-1 for setup sequence.
 - Use a rolling roadblock of work vehicles or police cruisers to delay traffic briefly while placing channelizing devices for the NB shift taper into the crossover.
 - Complete placement of roadway closure barricades, signs, and intrusion safeguards in the closed NB roadway.
 - Removal proceeds in reverse order.

Freeway Median Crossover for Night Work using Moveable Concrete Barrier (NWT-5)

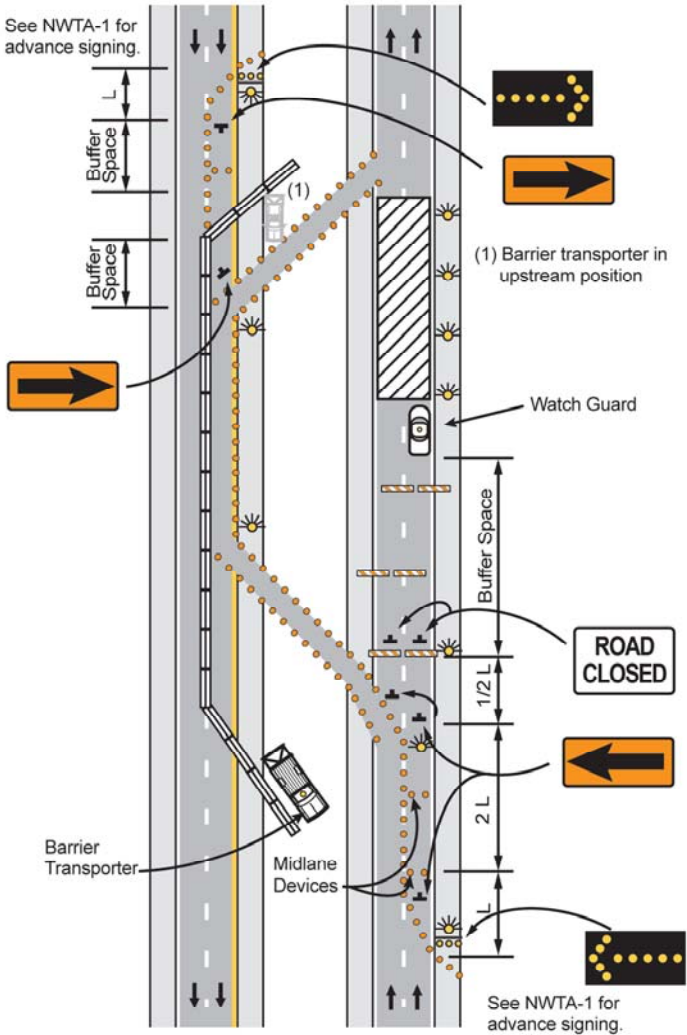

NWTA-6—NIGHT WORK ON TWO-LANE TWO-WAY ROADWAY USING FLAGGERS TO CONTROL ALTERNATING ONE-WAY TRAFFIC

See Figure NWTA-6. Refer to TA-10 for additional information.

1. Advance warning distances shown are appropriate for 55-mph highways. Distances may be adjusted for other speeds or for special situations.
2. SB warning signs are normally the same as shown for NB, but may be adjusted if conditions are different.
3. A portable or permanent CMS may be used to provide advance project information or driver guidance specific to the night operation.
4. Portable light towers are used to illuminate the flagger stations and work space.
5. Channelizing devices are drums, 1 ft by 2 ft vertical panels, or Type 2 barricades, and 3 ft cones only in the tangent sections.
6. Channelizing device spacing in feet equals 0.3 times the speed limit in miles per hour, with a maximum of 40 ft. Spacing is halved at ramps, intersections, and other conflict points.
7. Flagger stations are located to provide good sight distance approaching the flagger and to provide buffer space before the work space. In addition, flaggers are isolated from other workers and equipment.
8. Reflectorized stop-slow paddles are used for flagging. Flashing lights may be added to the staff.
9. Traffic control consisting of a flagger or other positive means is needed at all intersections and driveways within the one-way section.
10. Positive coordination between flaggers is essential. At a minimum, radio communication is needed. Pilot vehicles are especially appropriate for long one-way sections.
11. When approach speeds and volumes are high, a BE PREPARED TO STOP sign (W3-4) may be added upstream of the flagger sign (W20-7a).
12. Type A or Type B warning lights are used on the flagger signs to increase conspicuity.
13. Flagger, ONE LANE ROAD, and BE PREPARED TO STOP signs are removed when the roadway is returned to normal two-way operations. However, the ROAD WORK and other appropriate signs remain in place if needed to warn drivers of other conditions associated with the work.

Night Work on Two-Lane, Two-Way Roadway using Flagger to Control Alternating One-Way Traffic (NWTa-6)

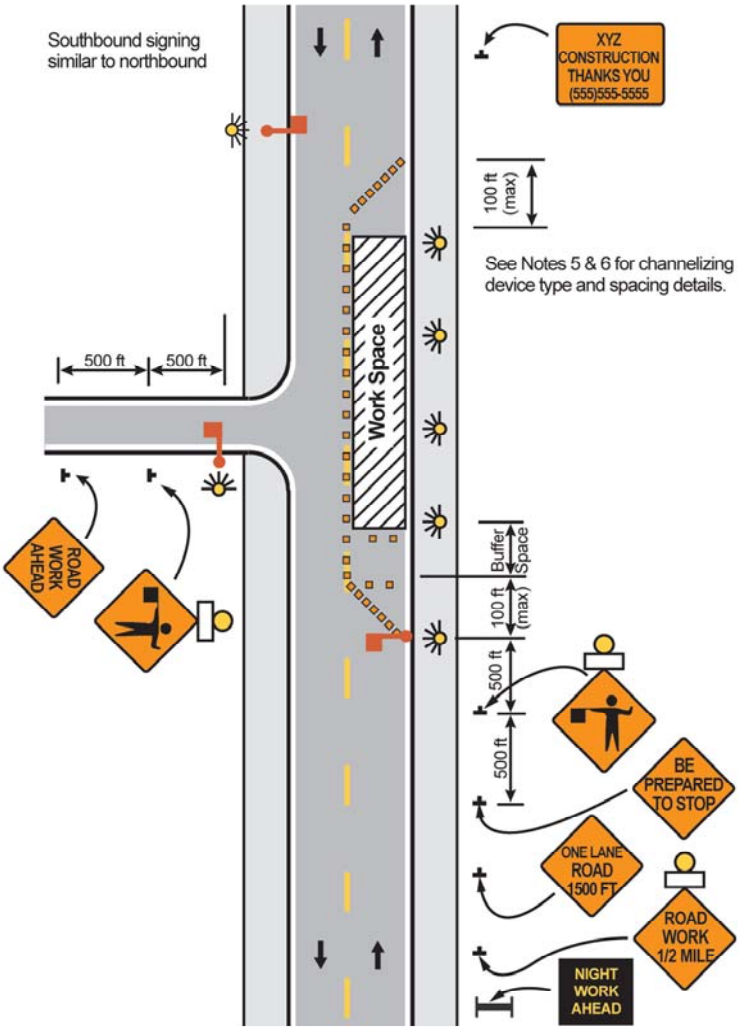

Full Message is: NIGHT WORK AHEAD / WATCH FOR FLAGGER

NWTA-7—NIGHT WORK LANE CLOSURE WITH LIGHTING PLAN DETAILS

See Figure NWTA-7. Refer to MUTCD TA-32 for additional information on lane closures.

1. Refer to NWTA-1 and NWTA-2 for details on advance signing and other traffic control devices used for night lane closures.
2. Details on channelizing device type and spacing are provided in NWTA-1 and NWTA-2. Thirty-six-inch cones spaced at a maximum of 20 ft may be used to separate opposing traffic if roadway width is limited.
3. Placement and spacing of portable light towers is based on specific luminaire properties shown in the table below. For other luminaire properties, placement and spacing must be changed to ensure that illuminance, uniformity, and glare criteria are satisfied.
4. Information on longitudinal and lateral buffer spaces is provided in NWTA-1.

Recommended Minimum Illuminance Levels and Categories for Nighttime Highway Maintenance and Construction

| Level of Illuminance | Illuminance in Footcandles (lux) | Area of Illumination | Type of Activity | Examples |
|----------------------|----------------------------------|--|---|---|
| I | 5(54) | General illumination throughout spaces | Performance of visual task of large sizes, medium contrast or low desired accuracy; or for general safety requirements | Excavation, sweeping and cleanup, movement area in the workzone |
| II | 10(108) | General illumination of tasks and around equipment | Performance of visual task of medium sizes, low to medium contrast or medium desired accuracy; or for safety on or around equipment | Paving, milling, concrete work; around paver, miller and other construction equipment |
| III | 20(216) | Illumination of task | Performance of visual task of small sizes, low contrast or high desired accuracy and fine finish | Crack filling, pothole filling, signalization or similar work requiring extreme caution and attention |

Night Work Lane Closure with Lighting Plan Details (NWT-7)

See NWT-1 for
advance signing
and other traffic
control details

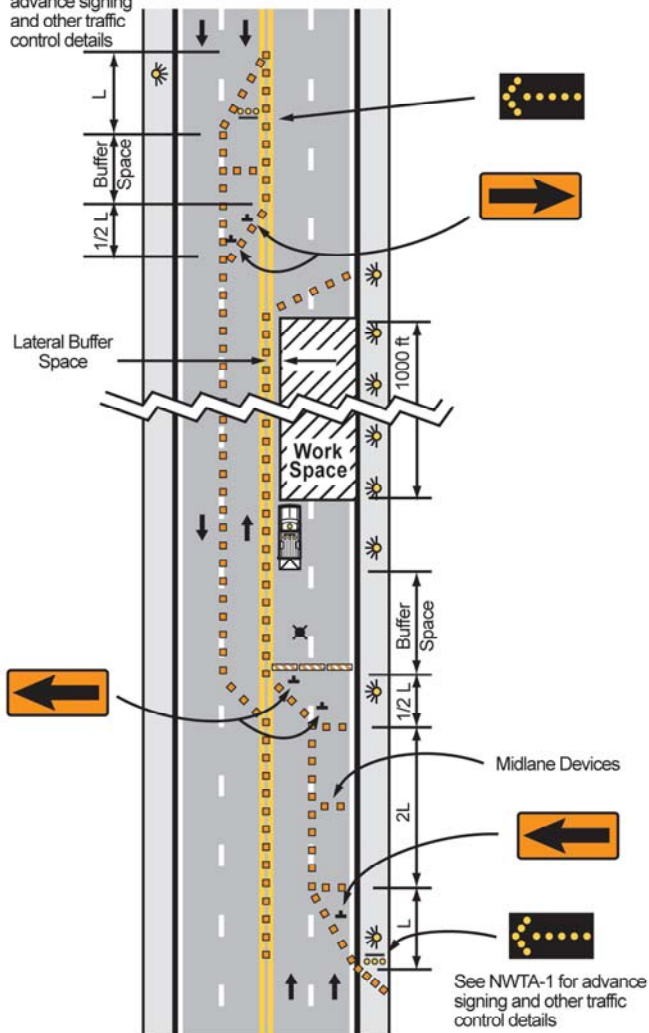

Liability

Steps to Minimize Liability:

- have a traffic control plan
- follow the MUTCD (Manual on Uniform Traffic Control Devices)
- minimize traffic disruptions
- promptly remove devices
- train all personnel
- inspect work zone sites periodically for conformance

Elements of a Good Inspection Program:

- routine schedule
- report form
- hazard identification
- adequate personnel and inventory
- repair verification
- formal documentation

Minimum Documentation should include:

- starting and ending time of work
- location of work
- type, condition and position of traffic control devices
- names of personnel
- type of equipment used
- any change in temporary or permanent regulatory devices
- additional information should be gathered in the event of an accident

Supervisor's Checklist

1. Follow Part 6 of the MUTCD. It is the national standard for work zone traffic control.
2. CDOT S-Standard Plans and Specifications and the Project Special Provisions should be used to supplement the MUTCD.
3. Have a plan before going to the work site.
4. Remove the devices in a timely manner
5. Ask yourself, "What is the driver's view?"

Training Information

For information regarding training for Flagging, Traffic Control Technicians and Traffic Control Supervisors, contact the Colorado Contractors Association (CCA) at 303-290-6611 or contact the ATSSA Roadway Safety Training Institute at 877-642-4637 or visit the website at

<http://www.atssa.com/TrainingCertification/CourseInformation.aspx>

Copies of this booklet may be purchased from CDOT Bid Plans at 4201 E. Arkansas Ave. in Denver. The phone number is 303-757-9313.

Index

- A, B, C (Defined), 2
- Buffer Space Guidance, 9
- Channelizing Devices - Detail, 3 – 6
- Duration of Work, 11
- Five Parts of a Traffic Control Zone, 8
- Flagging, 11 – 12
- Flashing / Advance Warning Arrow Display, 6
- Flashing Arrow Panels, 5
- Height and Lateral Location – Signs, 5
- Introduction, 2
- Liability, 97
- Lighting Devices, 7
- Pavement Markings, 7
- Portable Changeable Message Signs (PCMS), 7
- Signs, 2-3, 5
- Supervisor's Checklist, 97
- Taper Length Criteria for Work Zones, 9
- Taper Length, Number of Devices, and Device Spacing Table, 10
- Traffic Control Devices, 2 – 7
- Training Information, 97
- Typical Application Diagrams – Definitions, 13
- Typical Application Diagrams – Meaning of Symbols, 14

Typical Application Diagrams

Daytime Applications, 15-74

- Center Turn Lane Closed on Three-Lane Two-Way Road (CO-1), 73
- Closure at Side of Intersection (TA-27), 53 – 54
- Crosswalk Closures and Pedestrian Detours (TA-29), 57 – 58
- Detour for Closed Street (TA-20), 43 – 44
- Double Lane Closure on Freeway (TA-37), 65 – 66
- Interior Lane Closure on Multilane Street (TA-30), 59 – 60
- Lane Closure on Minor Street (TA-18), 41 – 42
- Lane Closure on Near Side of Intersection (TA-21), 45 – 46
- Lane Closure on Two-Lane Road Using Flaggers (TA-10), 29 – 30
- Lane Closure on Two-Lane Road Using Traffic Control Signals (TA-12), 31 – 32

Left Lane Closure on Far Side of Intersection (TA-23), 49 – 50
 Lane Shift on a Three-Lane Two-Way Road (CO-2), 74
 Mobile Operation on Multilane Road (TA-35), 63 – 64
 Mobile Operations on Two-Lane Road (TA-17), 39 – 40
 Multiple Lane Closure at Intersection (TA-25), 51 – 52
 Partial Exit Ramp Closure (TA-43), 69 – 70
 Right Lane Closure on Far Side of Intersection (TA-22), 47 – 48
 Road Closure with Diversion (TA-7), 25 – 26
 Road Closure with Off-Site Detour (TA-8), 27 – 28
 Short-Duration or Mobile Operation on Shoulder (TA-4), 19 – 20
 Shoulder Closure on Freeway (TA-5), 21 – 22
 Shoulder Work with Minor Encroachment (TA-6), 23 – 24
 Sidewalk Closures and Bypass Sidewalks (TA-28), 55 – 56
 Stationary Lane Closure on Divided Highway (TA-33), 61 – 62
 Surveying Along Centerline of Road with Low Traffic Volumes
 (TA-16), 37 – 38
 Temporary Road Closure (TA-13), 33 – 34
 Work Beyond the Shoulder (TA-1), 15 – 16
 Work in Center of Low-Volume Road (TA-15), 35 – 36
 Work in Vicinity of Exit Ramp (TA-42), 67 – 68
 Work in Vicinity of a Grade Crossing (TA-46), 71 – 72
 Work on Shoulders (TA-3), 17 – 18

Nighttime Applications, 75-96

Freeway Closure for Night Work with Traffic Diversion
 to Service Road (NWT A-2) , 81 – 82
 Freeway Median Crossover for Night Work Using Moveable Concrete
 Barrier (NWT A-5), 91 – 92
 Freeway Shoulder Closure Using Temporary Concrete Barrier with
 Lane Closure for Night Work (NWT A-4), 87 – 89
 Lane Closure on Divided Highway for Night Work (NWT A-1), 76 – 80
 Night Work on Two-Lane Roadway Using Flaggers to Control
 Alternating One-Way Traffic (NWT A-6), 93 – 94
 Night Work with Lane Closure with Lighting Plan Detail
 (NWT A-7), 95 – 96
 On-Ramp Closures for Night Work (NWT A-3), 83 – 86

Warning Lights, 7



DEPARTMENT OF TRANSPORTATION

**COLORADO DEPARTMENT
OF TRANSPORTATION**

Safety and Traffic Engineering Branch
4201 E. Arkansas Avenue, 3rd Floor
Denver, Colorado 80222
303-757-9662

with Funds provided by the
Federal Highway Administration